

KERN[®]

KERN & Sohn GmbH

Ziegelei 1
D-72336 Balingen
E-Mail: info@kern-sohn.com

Phone: +49-[0]7433- 9933-0
Fax: +49-[0]7433-9933-149
Internet: www.kern-sohn.com

Operating manual Compact balance

KERN FXN

Version 1.5
2018-08
GB



FXN-BA-e-1815



KERN FXN

Version 1.5 2018-08

Operating manual Compact balance

Contents

1	Technical data	3
1.1	Dimensions.....	5
2	Appliance overview.....	6
2.1	Overview of display	6
2.2	Keyboard overview.....	7
3	Basic Information (General)	8
3.1	Proper use.....	8
3.2	Improper Use	8
3.3	Warranty.....	8
3.4	Monitoring of Test Resources	8
4	Basic Safety Precautions	9
4.1	Pay attention to the instructions in the Operation Manual	9
4.2	Personnel training	9
5	Transport and storage	9
5.1	Testing upon acceptance	9
5.2	Packaging / return transport.....	9
6	Unpacking, Setup and Commissioning.....	10
6.1	Installation Site, Location of Use.....	10
6.2	Unpacking and placing.....	11
6.2.1	Scope of delivery.....	12
6.3	Battery operation.....	12
6.4	Initial Commissioning	14
7	Adjustment	14
7.1	Adjusting.....	14
7.1.1	Adjustment	15
7.1.2	Verification.....	16
8	Operation	18
8.1	Weighing	18
8.2	Taring.....	18
8.3	Parts counting	19
9	The menu	21
9.1	Navigation in the menu	21
9.2	Menu overview	22
9.3	Display background illumination	23
9.4	Automatic switch-off function Auto-Off.....	24
9.5	Checkweighing.....	25
9.6	Reset to factory setting	27
9.7	Hold function	28
10	Error messages	29
11	Instant help	29
12	Servicing, maintenance, disposal.....	30
12.1	Cleaning	30
12.2	Servicing, maintenance.....	30
12.3	Disposal.....	30
13	Declaration of Conformity	30

1 Technical data

KERN	FXN 3K-4N	FXN 6K-3N	FXN 10K-3N	FXN 30K-3N
Weighing range (max)	3 kg	6 kg	15 kg	30 kg
Readability (d)	0.5 g	1 g	5 g	5 g
Reproducibility	0.5 g	1 g	5 g	5 g
Linearity	5 g	2 g	10 g	10 g
Recommended adjustment weight, not added (class)	3 kg (M1)	6 kg (M1)	15 kg (M3)	30 kg (M1)
Stabilization time (typical)	2 sec.			
Units	g, kg, lb, oz,			
Warm-up time	10 min.			
Electric Supply	Battery operation: 4 x 1.5V Size D			
Auto-Off (rechargeable battery)	15 min., 5 min., 3 min., off			
Display type	LCD, digit height 25 mm			
Operating temperature	0° C + 40° C			
Humidity of air	25 % - 95 % (non-condensing)			
Dimensions of weighing plate (Stainless steel) (mm)	236 x 195			
Casing dimensions	240 x 280 x 120			
Dimensions, completely assembled (mm)	240 x 280 x 120			
Weight kg (net)	3.1			
IP protection	IP68 to DIN 60529			

KERN	FXN 3K-3M	FXN 6K-3M	FXN 10K-3M	FXN 30K-2M
Weighing range (max)	3 kg	6 kg	15 kg	30 kg
Readability (d)	1 g	2 g	5 g	10 g
Minimum load (Min)	20 g	40 g	100 g	200 g
Verification value (e)	1 g	2 g	5 g	10 g
Verification class	III	III	III	III
Reproducibility	1 g	2 g	5 g	10 g
Linearity	1 g	2 g	5 g	10 g
Recommended adjustment weight, not added (class)	3 kg (M1)	6 kg (M1)	15 kg (M1)	30 kg (M1)
Stabilization time (typical)	2 sec.			
Units	g, kg, lb, oz,			
Warm-up time	10 min.			
Electric Supply	Battery operation: 4 x 1.5V Size D			
Auto-Off (rechargeable battery)	15 min., 5 min., 3 min., off			
Display type	LCD, digit height 25 mm			
Operating temperature	-10° C + 40° C			
Humidity of air	25 % - 95 % (non-condensing)			
Dimensions of weighing plate (Stainless steel) (mm)	236 x 195			
Casing dimensions	240 x 280 x 120			
Dimensions, completely assembled (mm)	240 x 280 x 120			
Weight kg (net)	3.1			
IP protection	IP68 to DIN 60529			

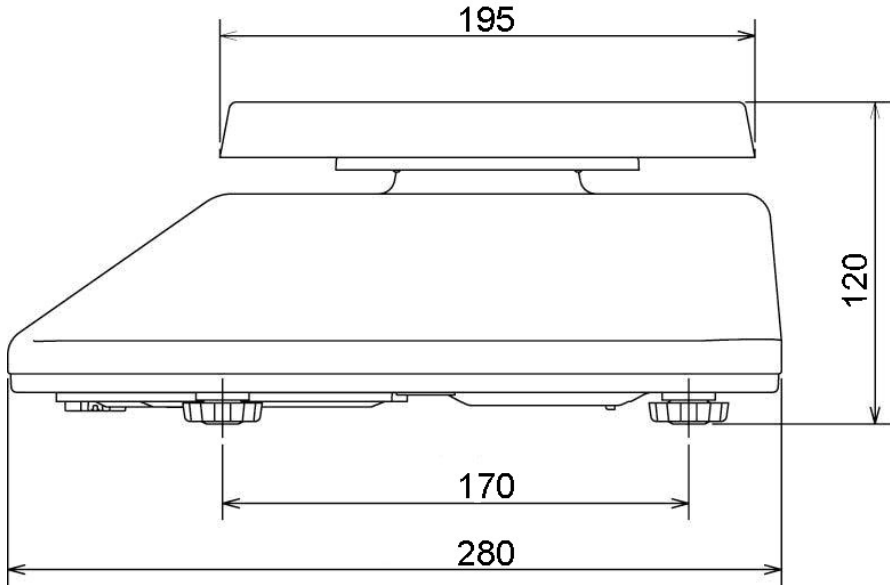
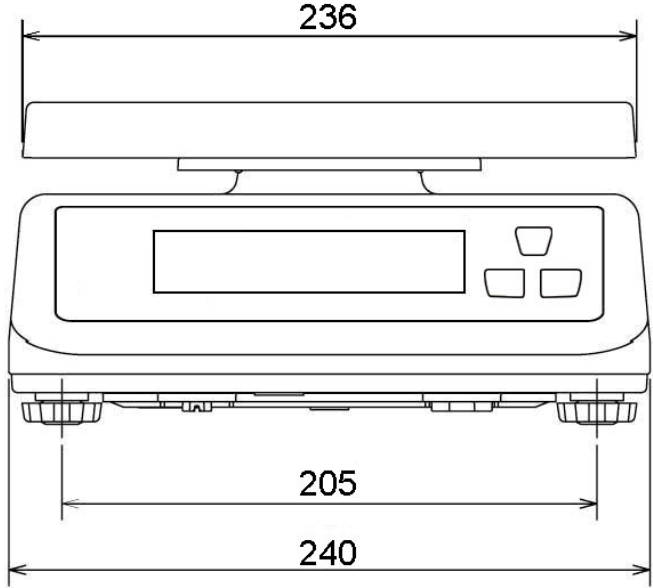

1.1 Dimensions





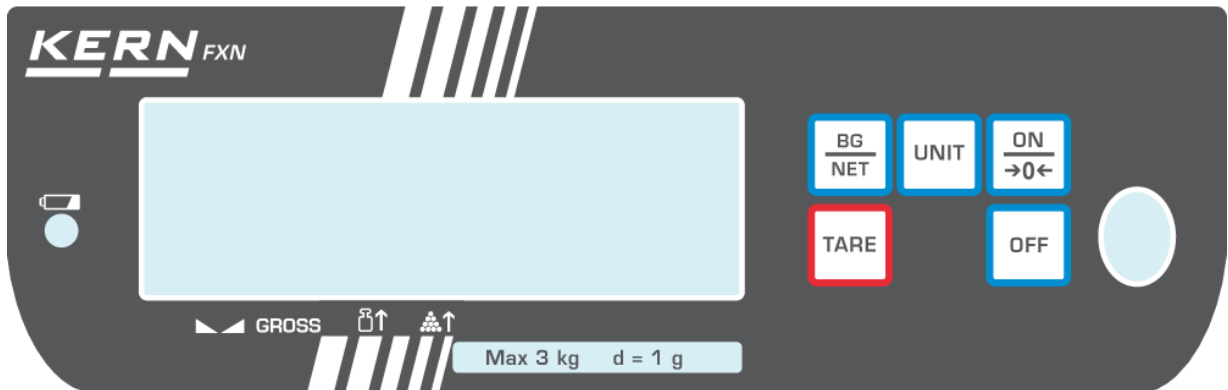

2 Appliance overview

2.1 Overview of display

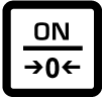

Display	Designation	Description
→0←	Zeroing display	Should the balance not display exactly zero despite empty scale pan, press the  button. The balance will be set to zero after a short standby time.
	Stability display	Scales are in a steady state
NET	Net weight display	Net weight will be displayed
	Capacity display Battery	Full battery capacity
kg	Display Weighing unit kg	Displayed weight in kg

2.2 Keyboard overview

Button	Designation	Function
	ON-button, zero button	Switch-on, set to zero
	OFF-button	Switching Off
	TARE button	Tare balance
	Unit button	Switch-over units
	Switch-over button	Switch-over gross weight / net weight

3 Basic Information (General)

3.1 Proper use

The balance you purchased is intended to determine the weighing value of material to be weighed. It is intended to be used as a “non-automatic balance”, i.e. the material to be weighed is manually and carefully placed in the centre of the weighing pan. As soon as a stable weighing value is reached the weighing value can be read.

3.2 Improper Use

Do not use balance for dynamic weighing. In the event that small quantities are removed or added to the material to be weighed, incorrect weighing results can be displayed due to the “stability compensation“. (Example: Slowly draining fluids from a container on the balance.)

Do not leave permanent load on the weighing pan. This may damage the measuring system.

Impacts and overloading exceeding the stated maximum load (max) of the balance, minus a possibly existing tare load, must be strictly avoided. Balance may be damaged by this.

Never operate balance in explosive environment. The serial version is not explosion protected.

The structure of the balance may not be modified. This may lead to incorrect weighing results, safety-related faults and destruction of the balance.

The balance may only be used according to the described conditions. Other areas of use must be released by KERN in writing.

3.3 Warranty

Warranty claims shall be voided in case

- Our conditions in the operation manual are ignored
- The appliance is used outside the described uses
- The appliance is modified or opened
- Mechanical damage or damage by media, liquids, natural wear and tear
- The appliance is improperly set up or incorrectly electrically connected
- The measuring system is overloaded

3.4 Monitoring of Test Resources

In the framework of quality assurance the measuring-related properties of the balance and, if applicable, the testing weight, must be checked regularly. The responsible user must define a suitable interval as well as type and scope of this test. Information is available on KERN’s home page (www.kern-sohn.com) with regard to the monitoring of balance test substances and the test weights required for this. The test weights and balances can be quickly and cheaply calibrated in the KERN calibration laboratory accredited by DKD (Deutsche Kalibrierdienst) (with reference to the national standard).

4 Basic Safety Precautions

4.1 Pay attention to the instructions in the Operation Manual



Carefully read this operation manual before setup and commissioning, even if you are already familiar with KERN balances.

4.2 Personnel training

The appliance may only be operated and maintained by trained personnel.

5 Transport and storage

5.1 Testing upon acceptance

When receiving the appliance, please check packaging immediately, and the appliance itself when unpacking for possible visible damage.

5.2 Packaging / return transport



- ⇒ Keep all parts of the original packaging for a possibly required return.
- ⇒ Only use original packaging for returning.
- ⇒ Prior to dispatch disconnect all cables and remove loose/mobile parts.
- ⇒ Reattach possibly supplied transport securing devices.
- ⇒ Secure all parts such as the glass wind screen, the weighing platform, power unit etc. against shifting and damage.

6 Unpacking, Setup and Commissioning

6.1 Installation Site, Location of Use

The balances are designed in a way that reliable weighing results are achieved in common conditions of use.

You will work accurately and fast, if you select the right location for your balance.

Therefore, observe the following for the installation site:

- Place scales on a stable, even surface;
- Avoid extreme heat as well as temperature fluctuation caused by installing next to a radiator or in the direct sunlight;
- Protect the balance against direct draughts due to open windows and doors;
- Avoid jarring during weighing;
- Protect the balance against high humidity, vapours and dust;
- Do not expose the device to extreme dampness for longer periods of time. Non-permitted condensation (condensation of air humidity on the appliance) may occur if a cold appliance is taken to a considerably warmer environment. In this case, acclimatize the appliance for ca. 2 hours at room temperature.
- Avoid static charge of goods to be weighed or weighing container.

Major display deviations (incorrect weighing results) may be experienced should electromagnetic fields (e.g. due to mobile phones or radio equipment), static electricity accumulations or instable power supply occur. Change location or remove source of interference.

6.2 Unpacking and placing

Carefully remove the balance from the packaging, remove plastic cover and setup balance at the intended workstation.

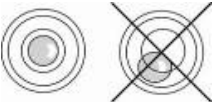
	<p>Level balance with foot screws until the air bubble of the water balance is in the prescribed circle.</p>
	

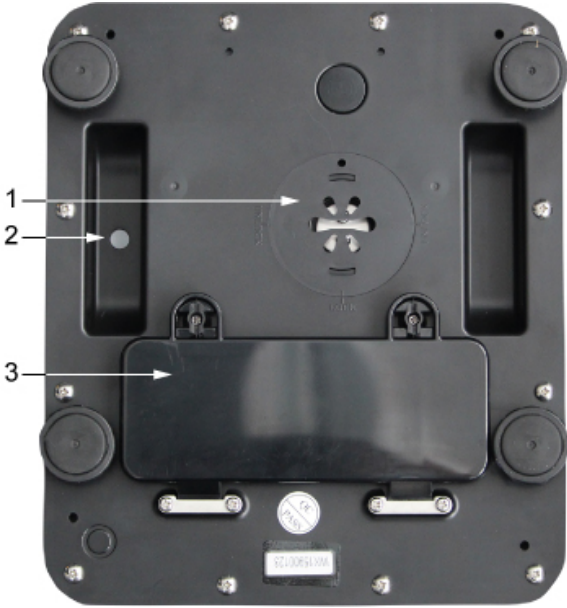
<ol style="list-style-type: none">1. Access point to membrane2. Pressure compensation (Goretex filter)3. Battery compartment



Membrane for protection type IP68

6.2.1 Scope of delivery

Serial accessories:

- Balance
- Weighing pan
- Operating manual
- 4 x 1.5V size D batteries

6.3 Battery operation

The operating time of the batteries with background illumination is 200 h, without background illumination 250 h.

In menu you can activate the AUTO-OFF function, see chap. 9.3. According to menu settings, the balance switches automatically off in order to spare the battery.

Insert rechargeable battery:

Example not verifiable models:



- ⇒ Open battery compartment.
- ⇒ Move both levers 90° to the left

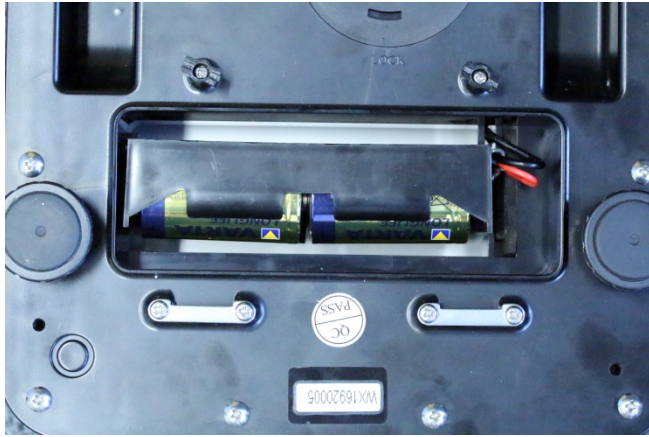

⇒ Insert 4 x 1.5V size D batteries.

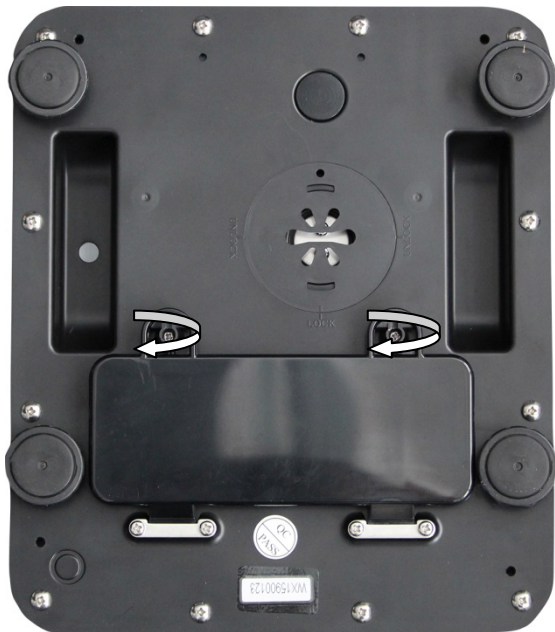
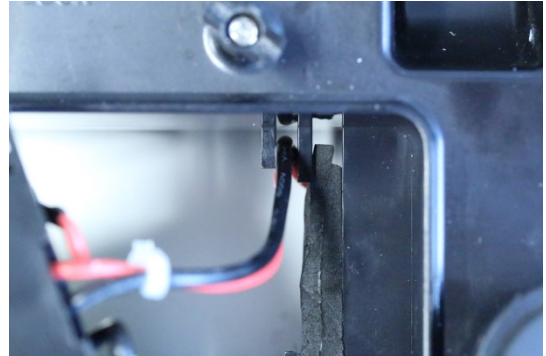

⇒ Close the battery compartment cover.

⇒ Move both levers 90° to the right



Ensure that the cables are not squeezed.

6.4 Initial Commissioning

In order to obtain exact results with the electronic balances, your balance must have reached the operating temperature (see warming up time chap. 1).

For this warm-up period the scale must be connected to the power supply (batteries).

The accuracy of the balance depends on the local acceleration of gravity.

Strictly observe hints in chapter "Adjustment".

7 Adjustment

As the acceleration value due to gravity is not the same at every location on earth, each balance must be coordinated - in compliance with the underlying physical weighing principle - to the existing acceleration due to gravity at its place of location (unless the balance has been pre-adjusted in the target location).

This adjustment process must be carried out for the first commissioning, after each change of location as well as in case of fluctuating environment temperature. To receive accurate measuring values it is also recommended to adjust the balance periodically in weighing operation.

7.1 Adjusting

Carry out adjustment as close as possible to the maximum load of the scales (see chap. 1 „Technical data“). The accuracy of the adjustment weight must correspond approximately to or, if possible, be better than, the readability d of the balance.















Info about test weights can be found on the Internet at: <http://www.kern-sohn.com>

Procedure when adjusting:

Observe stable environmental conditions. A warming up time (see chapter 1) is required for stabilization.

7.1.1 Adjustment

Operation

- ⇒ Turn off the balance and set the adjustment switch located on the bottom.
 - ⇒ Start the balance by pressing .
 - ⇒ Press  and  at the same time in weighing mode.
 - ⇒ The **01 FnC** indication appears.
-
- ⇒ Select **02 EC** by pressing .
 - ⇒ Confirm by pressing , the device displays **CAL 00**, the first digit is blinking.
 - ⇒ Enter **CAL 01** by pressing , go to the next digit and increase it by 1 using the  key.
 - ⇒ Confirm by pressing , the device displays the value of adjustment weight, e.g. „015.0000 kg“.
-
- ⇒ Change the value by pressing  and , and confirm by pressing ; or
 - ⇒ Apply the displayed value and confirm by pressing .
 - ⇒ For a while, the device will display **CENTER**. During that time, the balance determines the zero point.
 - ⇒ Then it will display a blinking value of adjustment weight, as previously selected.
 - ⇒ Place the appropriate adjustment weight and confirm by pressing .
 - ⇒ You will hear a sound signal, and the indication will start blinking.
 - ⇒ Remove the adjustment weight and press any key to complete the adjustment.
 - ⇒ The device will display the **CAL 01** indication. Enter **CAL 00** and confirm by pressing .
 - ⇒ The balance will display the **02 CAL** indication.
 - ⇒ Switch over the adjustment switch.
 - ⇒ Restart the balance. It will display the zero value. The balance is now in the weighing mode.

In case of any adjustment error or using an incorrect adjustment weight, the balance will display an error message. Repeat the adjustment.

7.1.2 Verification

General information:

Pursuant to Directive 2009/23/EC, balances must be verified if used in the following manners (scope specified by law):

- a) for trade, if the product price is determined by weighing;
- b) for production of medicines in pharmacies, and for analyses conducted at medical and pharmaceutical laboratories;
- c) for official purposes;
- d) for production of ready-made packagings.

In case of doubts, refer to the local Measurement Authority.

Guidelines for verification:

Balances marked in the technical specifications as suitable for verification have type-approval certificates applicable in the European Union. If the balance is to be used in one of the above-defined areas requiring verification, it must be verified and such verification must be renewed on a regular basis. The balance shall be re-verified in accordance with the national regulations. In Germany, the validity period of balance verification is usually 2 years. You must comply with the legal provisions applicable in the country of use!

i Verification of a balance without seals is invalid.

For balances with type-approval certificates, the seals indicate that the balance may be opened and maintained only by trained and authorised professional personnel. Destruction of the seals causes invalidity of the verification. You must comply with the national laws and regulations. In Germany, re-verification is required.

Position of seals and adjustment switch

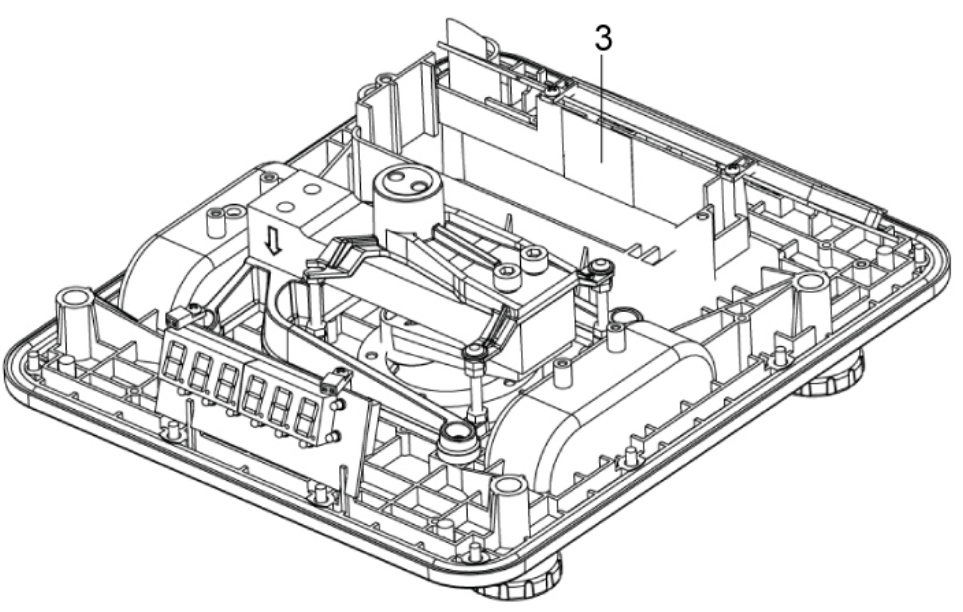
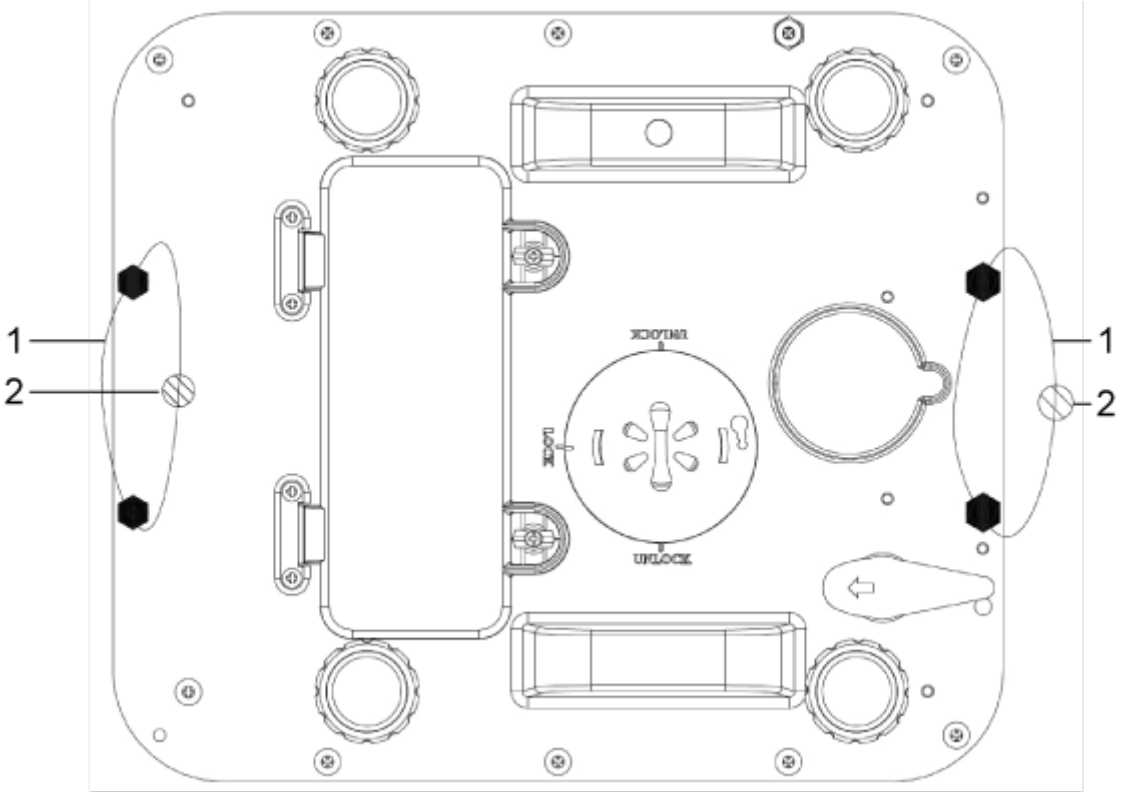

- 1. Wire of a verification seal
- 2. Seals
- 3. Adjustment switch

8 Operation

8.1 Weighing

- ⇒ Start balance by pressing .
- ⇒ The balance will carry out a self-test
- ⇒ As soon as the weight display shows „0.0“ and the triangle symbol ▼ above the stability display ▲▲ appears, the scale is ready for weighing.



- However, you can reset the weighing scale to zero by pressing the  button.

- ⇒ Switch off balance using .
The „0.0“ display disappears and the balance is switched off.

8.2 Taring

The tare weight of any preloads can be deducted by pressing a button so that the actual weight of the weighed material is displayed in subsequent weighings.









- ⇒ Put on weighing receptacles and press .
The zero display appears, and above the reset symbol →0← the stability symbol ▲▲ and the net weight symbol **NET** the triangle ▼ appears.
The weight of the container is now internally saved.



- ⇒ Place goods to be weighed in the weighing container.
The **net weight** of the goods to be weighed is displayed.



The weight of the weighing container will be displayed as a minus number (=gross weight) after removing the weighing container.







	<p>The tare weight is saved until it is deleted. Remove the load from the balance and press . The zero display appears and the triangle ▼ above the net weight symbol NET vanishes.</p>
	<p>Gross weight:</p> <ul style="list-style-type: none"> ⇒ Press  as long as the weighing container and the object to be weighed are on the weighing plate. ⇒ Remove the object to be weighed as well as the weighing container. The gross weight is displayed as a negative value.



8.3 Parts counting

Before the balance can count parts, it must know the average part weight (i.e. reference). Proceed by putting on a certain number of the parts to be counted. The balance determines the total weight and divides it by the number of parts, the so-called reference quantity. Counting is then carried out on the basis of the calculated average piece weight.

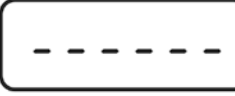
As a rule:

The higher the reference quantity the higher the counting exactness.

 ↓ 	<p>⇒ In weighing mode press  until the message < 0 Pcs > appears</p>
	<p>⇒ Use  to set the desired reference quantity (e.g. 100), selectable 10, 20, 50, 100 or 200</p>
 ↓ 	<p>⇒ Place as many parts to be counted (e.g. 100 items) as required by the reference number of parts.</p> <p>Acknowledge with . The weighing scales calculate the reference weight. The current quantity (such as 100 items) will be displayed.</p>

	⇒ Remove reference weight. The balance is from now in parts counting mode counting all units on the weighing plate.
	⇒ Back to Weighing mode by pressing the  button repeatedly.

i

By switching the scale off and then on again the scale starts in the parts counting mode. The current reference weight remains stored until the reference is set again or the power supply is interrupted.



The counting function is not active, if the weight is under 20d or if below the minimum piece weight ($< 0.2 D$) is reached.

Automatic reference optimization

In order to improve the counting exactness, the reference can be optimised by adding more pieces. At every reference optimisation, the reference weight is calculated anew. As the additional pieces increase the base for the calculation, the reference also becomes more exact.



While the automatic reference optimization function <FnC 07> is available the number of placed parts are 5 pieces more than the reference and less than double the reference, then balance will automatically re-sample the unit weight.







Indicator [▼] atop the symbol shows:

-  ↑ Number of parts placed on balance too small
-  ↑ Piece below minimum weight of piece







9 The menu

9.1 Navigation in the menu

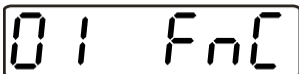
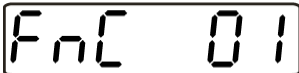



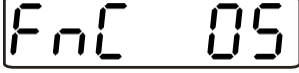

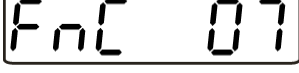
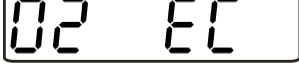



- ⇒ Start balance by pressing 
- ⇒ In weighing mode press the  and the  button at the same time.
- ⇒ **01 FnC** appears

- ⇒ Use the  button to change between the main menu items.
- ⇒ Use the  button to select the desired menu.
- ⇒ Enter the respective number for the required menu.
- ⇒ Use the  button to change between the numeric values.
- ⇒ Use the  button to increase the number.
- ⇒ Use the  button to reduce the number.
- ⇒ Confirm by pressing the  button









9.2 Menu overview

Menu item	Function
	Access to the settings and functions of the balance.
	Setting of background lighting
	Setting Auto-off function
	Hi / Lo / OK function. (Check weighing)
	Reset to standard setting
	Not documented
	HOLD function
	Automatic reference optimization
	External adjustment

9.3 Display background illumination











- ⇒ Start balance by 
- ⇒ Press  and  at the same time in weighing mode.
- ⇒ **01 FnC** appears
- ⇒ Confirm with  button
- ⇒ **FnC 00** appears
- ⇒ Use the  button to change between the numeric values.
- ⇒ Increase the number with  button.
- ⇒ Decrease the number with  button.
- ⇒ Now enter **FnC 01**
- ⇒ Confirm with  button
- ⇒ **bl on/off** appears (background illumination on/off)
- ⇒ Use  button to carry out the required adjustment and confirm by  button.
- ⇒ Switch balance off and on.

9.4 Automatic switch-off function Auto-Off

- ⇒ Start balance by pressing 
- ⇒ Press  and  at the same time in weighing mode.
- ⇒ **01 FnC** appears
- ⇒ Confirm with  button
- ⇒ **FnC 00** appears
- ⇒ Use the  button to change between the numeric values.
- ⇒ Use the  button to increase the number.
- ⇒ Use the  button to reduce the number.
- ⇒ Now enter **FnC 02**
- ⇒ Confirm by pressing the  button
- ⇒ Now select between the following values:
- 0: No Auto-off function
 - 1: After one minute the balance switches off automatically.
 - 2: After 2 minutes the balance switches off automatically.
 - 9: After 9 minutes the balance switches off automatically.
- ⇒ Confirm by pressing the  button
- ⇒ Now switch the balance off and on.

9.5 Checkweighing



In checkweighing an upper and a lower limit value can be established to ensure that the weighed goods are exactly within the established tolerance limits.

- ⇒ Start balance by 
- ⇒ Press  and  at the same time in weighing mode.
- ⇒ **01 FnC** appears
- ⇒ Confirm with  button
- ⇒ **FnC 00** appears
- ⇒ Use the  button to change between the numeric values.
- ⇒ Increase the number with  button.
- ⇒ Decrease the number with  button.
- ⇒ Now enter **FnC 03**
- ⇒ Confirm by  button
- ⇒ **00000h** appears flashing, enter upper limit value and confirm with 
- ⇒ **00000L** appears, enter lower limit value and confirm with 
- ⇒ **01100b** appears; here the acoustic signal is set (see tables below)
- ⇒ Enter required adjustment and confirm with 
- ⇒ Switch balance off and again on and weigh the material.

0	0	0	0	0	b
a	b	c			

• a	1 = acoustic signal on
	0 = acoustic signal off
• b	1 = acoustic signal at stable display
	0 = acoustic signal at instable display
• c	1 = acoustic signal when the weighed material is between the upper and the lower limit value
	0 = acoustic signal when the weighed material is outside the both limit values and bigger than 10d

In the display the following symbols will appear:









	——— 1	1. Weighing material above upper limit value
	——— 2	2. Weighing material within both limit values
	——— 3	3. Weighing material below lower limit value

Delete limit values:









Set upper and lower value to 0

9.6 Reset to factory setting

This function resets all balance settings to factory settings.

- ⇒ Start balance by 
- ⇒ Press  and  at the same time in weighing mode.
- ⇒ **01 FnC** appears
- ⇒ Confirm with  button
- ⇒ **FnC 00** appears
- ⇒ Use the  button to change between the numeric values.
- ⇒ Increase the number with  button.
- ⇒ Decrease the number with  button.
- ⇒ Now enter **FnC 04**
- ⇒ Confirm by  button
- ⇒ **rEturn** will appear
- ⇒ Confirm by  button
- ⇒ Now switch the balance off and on, all settings are reset to the respective factory setting.

9.7 Hold function

- ⇒ Start balance by 
- ⇒ Press  and  at the same time in weighing mode.
- ⇒ **01 FnC** appears
- ⇒ Confirm with  button
- ⇒ **FnC 00** appears
- ⇒ Use the  button to change between the numeric values.
- ⇒ Increase the number with  button.
- ⇒ Decrease the number with  button.
- ⇒ Now enter **FnC 06**
- ⇒ Confirm with  button, **hold 0** will appear flashing.
- ⇒ Enter required setting (see tables below)
- ⇒ Confirm with  button
- ⇒ Switch balance off and on again.

0	Hold function switched off	
1	Peak-Hold function	The maximum load value will be frozen and displayed. Delete value by pressing any button.
2	Hold 1	When the display is stable, the stable value is displayed. Delete value by pressing any button.
3	Hold 2	When the display is stable, the stable value is displayed. When the weighing plate is unloaded, the display goes to zero, the Hold function will be left automatically and the balance changes into the weighing mode.

10 Error messages

Display	Description	Remedy
E1	Zero range exceeded	Unload the balance
E2	Resetting range has not been reached.	Check if the correct weighing plate has been used.
oL	Overload	Unload the balance and adjust again.

11 Instant help

In case of an error in the program process, briefly turn off the balance and disconnect from power supply. The weighing process must then be restarted from the beginning.

Fault	Possible cause
The displayed weight does not glow.	▪ The balance is not switched on.
	▪ Batteries are inserted incorrectly or empty
	▪ No batteries inserted.
The displayed weight is permanently changing	▪ Draught/air movement
	▪ Table/floor vibrations
	▪ Weighing pan has contact with other objects. ▪ Electromagnetic fields / static charging (choose different location/switch off interfering device if possible)
The weighing value is obviously wrong	▪ The display of the balance is not at zero
	▪ Adjustment is no longer correct.
	▪ Great fluctuations in temperature. ▪ The balance is on an uneven surface. ▪ Electromagnetic fields / static charging (choose different location/switch off interfering device if possible)

Should other error messages occur, switch balance off and then on again. If the error message remains inform manufacturer.

12 Servicing, maintenance, disposal

12.1 Cleaning

Before cleaning, please remove batteries from the appliance

Please do not use aggressive cleaning agents (solvents or similar agents), but a cloth dampened with mild soap suds. Ensure that no liquid penetrates into the device and wipe with a dry soft cloth.

Loose residue sample/powder can be removed carefully with a brush or manual vacuum cleaner.

Spilled weighing goods must be removed immediately.

12.2 Servicing, maintenance

The appliance may only be opened by trained service technicians who are authorized by KERN.

Before opening, disconnect from power supply.

12.3 Disposal

Disposal of packaging and appliance must be carried out by operator according to valid national or regional law of the location where the appliance is used.

13 Declaration of Conformity

To view the current EC/EU Declaration of Conformity go to:

www.kern-sohn.com/ce