

BR16

ES | FR | IT | EN

INDICADOR

INDICATEUR

INDICATORE

INDICATOR

V.4
20171023



marca propiedad de | est une marque de | trade mark propriety of | marchio di proprietà di:

Pol. Empordà Internacional Calle F. Parcela 15-16
17469 VILAMALLA - (Girona) SPAIN
T. (34) 972 527 212 - F. (34) 972 527 211

GIROPES

El fabricante se reserva el derecho de modificar sin previo aviso las características de sus productos para introducir mejoras técnicas o cumplir con nuevas regulaciones oficiales./Le constructeur se réserve le droit de modifier les caractéristiques de ses produits en vue d'y apporter des améliorations techniques ou de respecter de nouvelles réglementations./The manufacturer reserves the right to modify the specifications of its products in order to make technical improvements or comply with new regulations. Il produttore si riserva il diritto di modificare senza preavviso le caratteristiche dei suoi prodotti al fine di introdurre dei miglioramenti tecnici o di conformarsi alle nuove normative ufficiali./Le constructeur se réserve le droit de modifier les caractéristiques de ses produits en vue d'y apporter des améliorations techniques ou de respecter de nouvelles réglementations./The manufacturer reserves the right to modify the specifications of its products in order to make technical improvements or comply with new regulations.

ES

INDICE

1. ESPECIFICACIONES	6
2. ALIMENTACIÓN	6
3. ANTES DE SU UTILIZACIÓN	6
4. CONSUMO	6
5. CONEXIÓN DE LA CÉLULA DE CARGA AL INDICADOR	6
6. DESCRIPCIÓN DEL DISPLAY Y DEL TECLADO	8
7. MODO CUENTA PIEZA	8
8. CONFIGURACIÓN DE PARÁMETROS	9
8.1 CUENTAS INTERNAS (A/D) <i>UF-1</i>	9
8.2 CONFIGURACIÓN DE LOS LÍMITES DE PESO (SUPERIOR E INFERIOR) <i>UF-2</i>	9
8.3 AUTODESCONEXIÓN AUTOMÁTICA <i>UF-3</i>	10
8.4 CONFIGURACIÓN DE LA ILUMINACIÓN DEL DISPLAY <i>UF-4</i>	10
8.5 FUNCIÓN HOLD <i>UF-5</i>	10
8.6 SALIDA DE DATOS RS-232 <i>UF-6</i>	11
8.7 CONFIGURACIÓN DE LA VELOCIDAD DEL CONVERTIDOR <i>UF-7 (*)</i>	14
8.8 CIEGA CERO <i>UF-8 (*)</i>	14
8.9 CONFIGURACIÓN DE LA GRAVEDAD <i>UF-9 (*)</i>	15
9. CALIBRACIÓN (SOLO PARA EL PERSONAL AUTORIZADO) (*)	15
9.1 CALIBRACIÓN DE CERO+PESO <i>ECC-1</i>	15
9.2 CALIBRACIÓN DE CERO <i>ECC-2</i>	15
9.3 CALIBRACIÓN DE PESO <i>ECC-3</i>	15
10. PARÁMETROS TÉCNICOS	16
11. GARANTÍA	20

FR

1. SPÉCIFICATIONS	21
2. ALIMENTATION	21
3. AVANT SON UTILISATION	21
4. CONSOMMATION	21
5. CONNEXION DE LA CAPTEURS DE CHARGE À L'INDICATEUR	21
6. DESCRIPTION DE L'AFFICHAGE ET DU CLAVIER	23
7. MODE COMPTE PIÈCES	23
8. CONFIGURATION DE PARAMÈTRES	24
8.1 COMPTES INTERNES (A/D) <i>UF-1</i>	24
8.2 CONFIGURATION DES LIMITES DE POIDS (SUPÉRIEURE ET INFÉRIEURE) <i>UF-2</i>	24
8.3 AUTODÉCONNEXION AUTOMATIQUE <i>UF-3</i>	25
8.4 CONFIGURATION DE L'ÉCLAIRAGE DE L'AFFICHAGE <i>UF-4</i>	25
8.5 FONCTION HOLD <i>UF-5</i>	25
8.6 SORTIE DE DONNÉES RS-232 <i>UF-6</i>	26
8.7 CONFIGURATION DE LA VITESSE DU CONVERTISSEUR <i>UF-7 (*)</i>	29
8.8 ZÉRO AVEUGLE <i>UF-8 (*)</i>	29
8.9 CONFIGURATION DE LA GRAVITÉ <i>UF-9 (*)</i>	29
9. ÉTALONNAGE (UNIQUEMENT POUR LE PERSONNEL AUTORISÉ) (*)	30
9.1 ÉTALONNAGE DE ZÉRO+POIDS <i>ECC-1</i>	30
9.2 ÉTALONNAGE DE ZÉRO <i>ECC-2</i>	30
9.3 ÉTALONNAGE DE POIDS <i>ECC-3</i>	30
10. PARAMÈTRES TECHNIQUES	30
11. GARANTIE	35

IT

1. SPECIFICHE	36
2. ALIMENTAZIONE	36
3. PRIMA DELL'USO	36
4. CONSUMO	36
5. COLLEGAMENTO DELLA CELLA DI CARICO ALL'INDICATORE	36
6. DESCRIZIONE DEL DISPLAY E DELLA TASTIERA	38
7. MODALITÀ CONTAPEZZI	38
8. CONFIGURAZIONE DEI PARAMETRI	39
8.1 CALCOLI INTERNI (A/D) <i>UF-1</i>	39
8.2 CONFIGURAZIONE DEI LIMITI DI PESO (SUPERIORE E INFERIORE) <i>UF-2</i>	39
8.3 DISATTIVAZIONE AUTOMATICA <i>UF-3</i>	40
8.4 CONFIGURAZIONE DELL'ILLUMINAZIONE DEL DISPLAY <i>UF-4</i>	40
8.5 FUNZIONE HOLD <i>UF-5</i>	40
8.6 USCITA DEI DATI RS-232 <i>UF-6</i>	41
8.7 CONFIGURAZIONE DELLA VELOCITÀ DEL CONVERTITORE <i>UF-7</i> (*)	44
8.8 CIECA ZERO <i>UF-8</i> (*)	44
8.9 CONFIGURAZIONE DELLA GRAVITÀ <i>UF-9</i> (*)	45
9. CALIBRAZIONE (SOLO PER IL PERSONALE AUTORIZZATO) (*)	45
9.1 CALIBRAZIONE DELLO ZERO+PESO <i>ECF-1</i>	45
9.2 CALIBRAZIONE DELLO ZERO <i>ECF-2</i>	45
9.3 CALIBRAZIONE DEL PESO <i>ECF-3</i>	45
10. PARAMETRI TECNICI	46
11. GARANZIA	50

EN

1. SPECIFICATIONS	51
2. POWER	51
3. BEFORE USE	51
4. CONSUMPTION	51
5. CONNECTING THE CHARGING CELL TO THE INDICATOR	51
6. DISPLAY AND KEYBOARD DESCRIPTION	53
7. CONTACTS	53
8. PARAMETER CONFIGURATION	54
8.1 INTERIOR CALCULATIONS (A/D) <i>UF-1</i>	54
8.2 CONSTRUCTION OF WEIGHT LIMIT (HIGH AND LOWER) <i>UF-2</i>	54
8.3 AUTOMATIC DISARMING <i>UF-3</i>	55
8.4 CONFIGURING DISPLAY LIGHTING <i>UF-4</i>	55
8.5 HOLD FUNCTION <i>UF-5</i>	55
8.6 USCITA DEI DATI RS-232 <i>UF-6</i>	56
8.7 CONVERTER SPEED CONFIGURATION <i>UF-7</i> (*)	59
8.8 BLIND ZERO <i>UF-8</i> (*)	59
8.9 CONFIGURATION OF GRAVITY <i>UF-9</i> (*)	59
9. CALIBRATION (ONLY FOR AUTHORIZED PERSONNEL) (*)	60
9.1 ZERO CALIBRATION + WEIGHT <i>ECF-1</i>	60
9.2 ZERO CALIBRATION <i>ECF-2</i>	60
9.3 WEIGHT CALIBRATION <i>ECF-3</i>	60
10. TECHNICAL PARAMETERS	60
11. WARRANTY	64

1. ESPECIFICACIONES

BR16

Precisión	Clase III
Rango de sensibilidad de la célula de carga	1.5 ~ 3.0mV/V
No linealidad	≤0.01%F.S
Voltaje célula	DC 5V
Escalón	1/2/5 (seleccionable)
Frecuencia de muestreo	20 veces por segundo (fuera de meteorología)
Resolución interna	300.000~600.000

2. ALIMENTACIÓN

BR16

Entrada	100/240VAC
Salida	12V/1A
Batería recargable	6V/4Ah

3. ANTES DE SU UTILIZACIÓN

- 1) Situar la balanza sobre una superficie firme y llana, no exponerla en ambientes con vibraciones.
- 2) Utilizar una fuente eléctrica independiente, evitar perturbaciones eléctricas.
- 3) No colocar ningún objeto sobre la plataforma en el momento de poner en marcha el indicador.
- 4) Por favor, permita que la balanza se precaliente durante 2-3 minutos antes de su utilización.
- 5) Evitar cambios de temperatura muy bruscos y corrientes de aire.
- 6) No sobrecargar la balanza, nunca exceder la capacidad máxima.

4. CONSUMO

- Consumo normal en reposo: approx. 12mA - 333h
- Consumo con la retroiluminación: aprox. 36mA - 111,11h
- Consumo con la retroiluminación y salida RS-232: aprox. 48mA-83h
- Duración de la batería: sin la retroiluminación, aprox. 320 horas

5. CONEXIÓN DE LA CÉLULA DE CARGA AL INDICADOR

- 1) El conector de la célula de carga es de 7 pins.
- 2) Cuando el indicador está trabajando, no quitar el conector de la célula de carga, este acto podría dañar el equipo

ESQUEMA CÉLULA DE 7 PINS

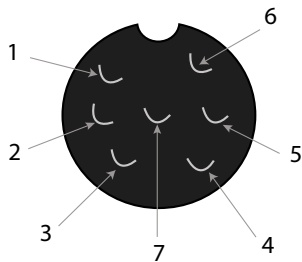
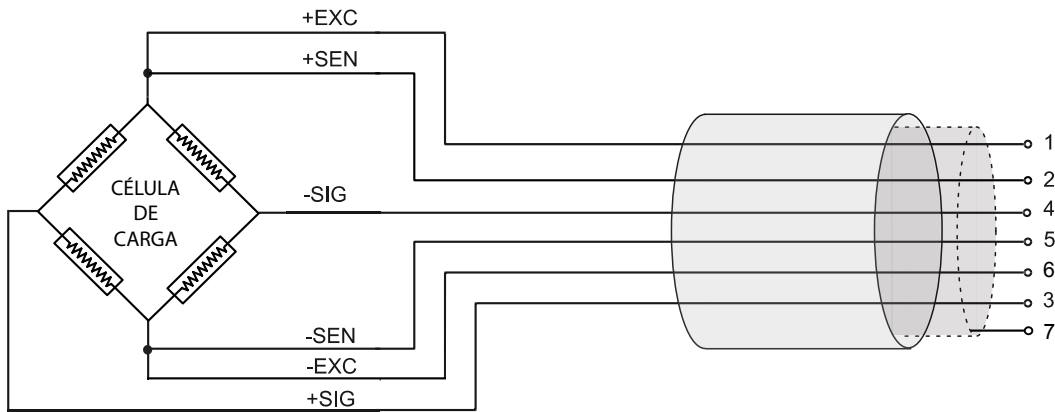

PIN 1	EXC +
PIN 2	SEN +
PIN 3	SIG +
PIN 4	SIG -
PIN 5	SEN -
PIN 6	EXC -
PIN 7	GND

CONNEXIÓN RS232

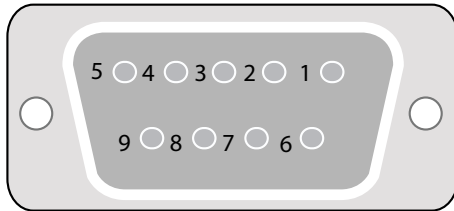

2	Tx
3	Rx
5	GND

PROTOCOLO

UART signal of EIA-RS232 C

SEÑAL UART DE EIA-RS232 C	
Salida serie	1200 / 2400 / 4800 / 9600 / 19200 / 34800 bps
Bits de datos	8 bits
Bits de paridad	No
Bits de stop	1 bit

INFORMACIÓN CABECERAS

Cabecera 1 (2 BYTES)	Cabecera 2 (2 BYTES)
OL – Sobrecarga	
ST – Estable	NT – Peso neto
US – INESTABLE	GS – Peso bruto

6. DESCRIPCIÓN DEL DISPLAY Y DEL TECLADO

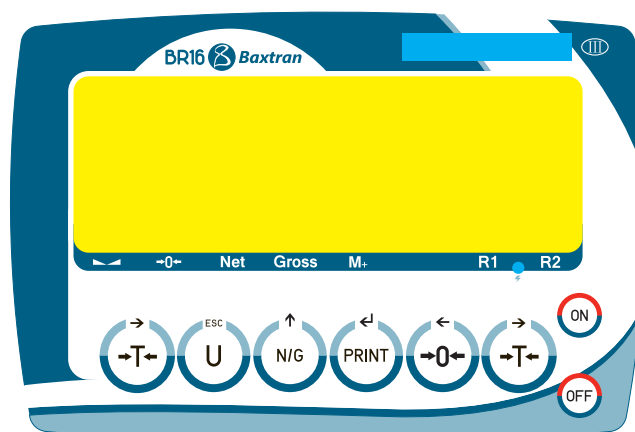

Pulsar esta tecla para encender la balanza.



Mantener pulsada esta tecla durante 2 segundos para apagar el indicador.



1º función Para cambiar de unidad de pesaje.

2º función Para salir de un menú.



1º función Para poner la lectura del display a cero "0", el valor del display tiene que ser menor al $\pm 2\%$ de la capacidad máxima.

2º función Para desplazarse un espacio hacia la izquierda o hacia abajo dentro del modo programación.



1º función Para sustraer el peso de un contenedor.

2º función Para desplazarse un espacio hacia la derecha o hacia arriba dentro del modo programación.



1º función Para visualizar el peso neto o bruto de un producto cuando se ha realizado una Tara. Cuando se visualiza el peso bruto del producto las demás teclas quedan deshabilitadas.

2º función Para incrementar los valores dentro del modo programación.



1º función Transmisión manual de datos a través del puerto RS-232 a un PC o impresora y según modo elegido.

2º función Tecla de confirmación dentro del modo programación.

7. MODO CUENTA PIEZA

1. Presione la tecla hasta que la pantalla muestre Pcs.
2. Presione sucesivamente para seleccionar la cantidad de piezas de la muestra. La pantalla mostrará sucesivamente C 10 / C20 / C 50 / C 100 / C 200.
3. Sitúe la muestra sobre la plataforma, espere que se encienda el indicador de estabilidad y presione la tecla .
4. Sitúe el producto encima de la plataforma y la pantalla mostrará el número de piezas.

La acumulación y envío de datos dependerá del modo elegido en el apartado UF-6.

- Para volver al modo de pesaje normal, presione la tecla .
- Si desea volver al modo cuenta piezas, usando la misma muestra de referencia, presione nuevamente la tecla .
- Si desea cambiar la muestra de referencia, vuelva a repetir los pasos descritos anteriormente.

8. CONFIGURACIÓN DE PARÁMETROS

8.1	CUENTAS INTERNAS (A/D)	UF-1
8.2	CONFIGURACIÓN DE LOS LÍMITES DE PESO (SUPERIOR E INFERIOR)	UF-2
8.3	AUTODESCONEXIÓN AUTOMÁTICA	UF-3
8.4	CONFIGURACIÓN DE LA ILUMINACIÓN DEL DISPLAY	UF-4
8.5	FUNCIÓN HOLD	UF-5
8.6	SALIDA DE DATOS RS-232	UF-6
8.7	CONFIGURACIÓN DE LA VELOCIDAD RS-232	UF-7
8.8	PROMEDIO DEL CERO	UF-8
8.9	CONFIGURACIÓN DE LA GRAVEDAD	UF-9

Para acceder a la configuración de parámetros, pulsar al mismo tiempo las teclas y .

Pulsar las teclas y para navegar por el menú (UF-1 ~ UF-9).

Pulsar la tecla para acceder al parámetro y confirma.

Pulsar la tecla para salir del menú y volver al modo de pesaje.

8.1 CUENTAS INTERNAS (A/D) | UF-1

1. Pulsar la tecla para visualizar las cuentas internas de la balanza.
2. Para pasar al siguiente parámetro, pulsar la tecla y la pantalla indicará el voltaje de la batería.
3. Pulsar la tecla para volver al menú *UF*.





8.2 CONFIGURACIÓN DE LOS LÍMITES DE PESO (SUPERIOR E INFERIOR) | UF-2

1. Pulsar la tecla para acceder al parámetro.
2. El display mostrará el mensaje "00000L" (Límite inferior).
3. Utilizar las teclas y para mover el cursor y la tecla para seleccionar el número deseado.
4. Pulsar la tecla para confirmar.
5. El display mostrará "00000H" (Límite superior).
6. Utilizar las teclas y para mover el cursor y la tecla para seleccionar el número deseado.
7. Pulsar la tecla para confirmar.
8. El display mostrará el valor

A B C
0 0 0

(configuración de la alarma)



DISPLAY	VALOR	ESTABILIDAD
A	0	no hace falta estabilidad para sonar
	1	hace falta estabilidad para sonar
B	0	siempre 0
C	0	alarma apagada
	1	alarma suena si está en la franja Ok (entre límites Lo y Hi)
	2	alarma suena si está por debajo del límite inferior Lo o por encima del límite superior Hi





- Utilizar las teclas  y  para mover el cursor y la tecla  para seleccionar el número deseado.
- Pulsar la tecla  para confirmar.

Las indicaciones en pantalla **Lo**, **Ok**, **Hi** aparecerán en pantalla según el peso.

8.3 AUTODESCONEXIÓN AUTOMÁTICA | UF-3



MODOS:



	Autodesconexión desactivada.
	Autodesconexión activada, la balanza se apagará automáticamente transcurrido 1 minuto sin ser utilizada. Seleccione el tiempo de autodesconexión entre 1 y 99 minutos.

- Pulsar la tecla  para acceder al parámetro.
- Utilizar las teclas  y  para mover el cursor y la tecla  para seleccionar el tiempo deseado.
- Pulsar la tecla  para confirmar.

8.4 CONFIGURACIÓN DE LA ILUMINACIÓN DEL DISPLAY | UF-4



MODOS:

	Automática.
	Iluminación activada siempre.
	Iluminación desactivada.

- Pulsar la tecla  para acceder al parámetro.
- Pulsar la tecla  para seleccionar el modo deseado.
- Pulsar la tecla  para confirmar.

8.5 FUNCIÓN HOLD | UF-5











Los modo **HOLD** permiten que, una vez retirado el objeto del plato, el display mantiene el peso fijado hasta la presión de  (función muy útil para el pesaje de animales). **Nota: si usted ha activado el modo hold, NO PODRÁ UTILIZAR LA FUNCIÓN LÍMITES NI ACUMULACIÓN.**

- Pulsar la tecla  para acceder al parámetro.
- Pulsar la tecla  para seleccionar el modo deseado.
- Pulsar la tecla para  confirmar.

MODOS:



- **HOLD 0** : Desactivado.
- **HOLD 1** : Animal en movimiento.
- **HOLD 2** : Valor de pico.
- **HOLD 3** : Hold estable.
- **HOLD 4** : Hold estable con auto cancelación a cero.

HOLD 1.

- Una vez se ha accedido a este parámetro, la pantalla muestra **Pct**,
- Use las teclas   y  para mover el cursor y la tecla  para seleccionar el valor del rango de HOLD deseado de 001 a 100.
- Pulsar la tecla  para confirmar.
- La pantalla mostrará **time 8**, use las teclas   y  para mover el cursor y la tecla  para seleccionar el número de repeticiones deseado durante el rango de hold.
- Pulsar la tecla  para confirmar.

Ejemplo: Pct pequeño y time grande implica más precisión y mayor tiempo de estabilización.

8.6 SALIDA DE DATOS RS-232 | UF-6

1. Pulsar la tecla  para acceder al parámetro.
2. Pulsar la tecla  para seleccionar la velocidad de transmisión deseada.
3. Pulsar la tecla  para confirmar.

FORMATO DE LOS DATOS

Ningún formato

232 0 Salida RS-232 Desactivada

Formato 1 PC

FORMATO AUTOMÁTICO DE PESO O PIEZAS

ST,GS,+0003. 58 kg <CR><LF>

ST,GS,+0000250pcs <CR><LF>

ENVÍO DE TRAMA

232 1 Envío de trama, sin acumulación, cuando consigue estabilidad con **formato 1**.

232 2 Envío de trama continuo con **formato 1**.

232 3 Envío de trama, sin acumulación, manual presionando la tecla  con **formato 1**.

Formato 2 PC

FORMATO AUTOMÁTICO DE PESO O PIEZAS

+0000.64kg<CR><LF>

+0000100pcs<CR><LF>

ENVÍO DE TRAMA

232 4 Envío de trama, sin acumulación, cuando consigue estabilidad con **formato 2**.

232 5 Envío de trama continuo con **formato 2**.

232 6 Envío de trama, sin acumulación, manual presionando la tecla  con **formato 2**.

Formato 3 impresora

FORMATO AUTOMÁTICO DE PESO O PIEZAS

S/N	WT/kg	S/N	WT/pcs
0001	0.64	0001	20
0002	0.70	0002	21
0003	0.64	0003	45
-----		0003	86
0003	1.98		

232 7 Envío de trama y acumulación manual, pasando por cero y presionando la tecla  con **formato 3**.

0002 0.70

Si estando la pantalla a 0, se presiona dos veces seguidas la tecla  se imprime la línea de total.

0003 1.98

Y se borra la memoria de pesadas.

Nota: Acumulación y totalización no disponible para metrología legal.

ENVÍO DE TRAMA

232 8 Envío de trama y acumulación automática a la estabilidad, pasando por 0 con **formato 3**.

0002 21

Si estando la pantalla a 0, se presiona dos veces seguidas la tecla  se imprime la línea de total.

0003 86

Y se borra la memoria de pesadas.

Nota: Acumulación y totalización no disponible para metrología legal

Formato 4 impresora

FORMATO AUTOMÁTICO
DE PESO O PIEZAS

TICKET NO.0003	
G 0.64kg	
T 0.00kg	
N 0.64kg	
TOTAL NUMBER OF TICKETS 0003	
TOTAL	
NET 1.92	

TICKET NO.0002	
G 20pcs	
T 0pcs	
N 20pcs	
TOTAL NUMBER OF TICKETS 0002	
TOTAL	
NET 40	

NOTA: totalización no disponible en metrología legal.

ENVÍO DE TRAMA

232 9

Envío de trama y acumulación manual, pasando por cero y presionando la tecla  con **formato 4**

TICKET NO.0003
G 0.64kg
T 0.00kg
N 0.64kg

Si estando la pantalla a 0, se presiona dos veces seguidas la tecla



se imprime el resumen de tiquets

TOTAL NUMBER OF TICKETS 0003
TOTAL
NET 1.92

Y se borra la memoria de pesadas

NOTA: totalización no disponible en metrología legal.

ENVÍO DE TRAMA

232 10

Envío de trama y acumulación automática a la estabilidad, pasando por cero y presionando la tecla  con **formato 4.**

TICKET NO.0002
G 20pcs
T 0pcs
N 20pcs

Si estando la pantalla a 0, se presiona dos veces seguidas la tecla



se imprime el resumen de tiquets

TOTAL NUMBER OF TICKETS 0003
TOTAL
NET 1.92

Y se borra la memoria de pesadas

NOTA: totalización no disponible en metrología legal.

NOTA: Cada vez que se hace una acumulación, el visor muestra el total acumulado durante 3 segundos.

FORMATO 1 (232 1 ~ 3):

18 BYTES ASCII PARA LAS UNIDADES kg, g, t, lb

1	2	,	1	2	,	1	2	3	4	5	6	7	8	1	2	CR	LF
Cabecera 1			Cabecera 2			Datos								Unidad			

21 BYTES ASCII PARA LAS UNIDADES tl, T, lboz

1	2	,	1	2	,	1	2	3	4	5	6	7	8	9	1	2	3	4	CR	LF
Cabecera 1			Cabecera 2			Datos									Unidad					

19 BYTES ASCII PARA LA UNIDAD pcs

1	2	,	1	2	,	1	2	3	4	5	6	7	8	1	2	3	CR	LF
Cabecera 1			Cabecera 2			Datos								Unidad				

FORMATO 2 (232 4 ~ 6):

12 BYTES ASCII PARA LAS UNIDADES kg, g, t, lb

1	2	3	4	5	6	7	8	1	2	CR	LF
Datos								Unidad			



15 BYTES ASCII PARA LAS UNIDADES tl, T, lboz

1	2	3	4	5	6	7	8	9	1	2	3	4	CR	LF
Datos									Unidad					

13 BYTES ASCII PARA LA UNIDAD pcs

1	2	3	4	5	6	7	8	1	2	3	CR	LF
Datos								Unidad				

8.7 CONFIGURACIÓN DE LA VELOCIDAD DEL CONVERTIDOR | UF--7 (*)

1. Pulsar la tecla  para acceder al parámetro.
2. Pulsar la tecla  para seleccionar el modo deseado.

Modo 1 Normal

Modo 2 Rápido

Modo 3 Lento

3. Pulsar la tecla  para confirmar.

8.8 CIEGA CERO | UF--8 (*)



Muestra 0 en pantalla hasta llegar a la siguiente división seleccionada. Empezando a mostrar valores a partir de esta división.

Ejemplo:





báscula con e=2g

ciega en 5 divisiones

Mostrará 0 hasta llegar a $2 \times 5 = 10g$ el primer valor que mostrará será 12g.

1. Pulsar la tecla  para acceder al parámetro.
2. Pulsar la tecla  para seleccionar.
3. Pulsar la tecla  para confirmar.





8.9 CONFIGURACIÓN DE LA GRAVEDAD | *UF-9 (*)*

1. Pulsar la tecla  para acceder al parámetro.
2. Para cambiar el valor, pulsar la tecla , seguidamente utilizar las teclas, utilizar las teclas  y  para mover el cursor y la tecla para seleccionar el número deseado.







9. CALIBRACIÓN (SOLO PARA EL PERSONAL AUTORIZADO) (*)





9.1	CALIBRACIÓN DE CERO + PESO (SPAN)	<i>ECF-1</i>
9.2	CALIBRACIÓN DE CERO	<i>ECF-2</i>
9.3	CALIBRACIÓN DE PESO (SPAN)	<i>ECF-3</i>

0. Mover el switch interno a CAL ON.
1. Dentro del modo normal de pesaje, pulsar las teclas  y , el display mostrará el mensaje **ECF-1**.
2. Pulsar las teclas  y , para seleccionar la función deseada: **ECF-1, ECF-2 o ECF-3**







9.1 CALIBRACIÓN DE CERO+PESO | *ECF-1*

- Pulsar la tecla , el display mostrará CALZ.
- Pulsar la tecla , para poner a cero la lectura del display.
- Pulsar las teclas  y  para mover el cursor.
- Pulsar la tecla  introducir el valor de la pesa de calibración.
- Colocar la pesa de calibración sobre la plataforma y pulsar la tecla  para efectuar la calibración una vez la lectura sea estable.

9.2 CALIBRACIÓN DE CERO | *ECF-2*

- Pulsar la tecla , el display mostrará CALZ.
- Pulsar la tecla , para poner la lectura del display a cero.
- Pulsar la tecla , para efectuar la calibración.

9.3 CALIBRACIÓN DE PESO | *ECF-3*

- Pulsar la tecla , el display mostrará el valor del peso de calibración
- Pulsar las teclas  y  para mover el cursor.
- Pulsar la tecla  para modificar el valor de la pesa de calibración.
- Pulsar la tecla , para confirmar.
- Colocar la pesa de calibración sobre la plataforma y pulsar la tecla  para efectuar la calibración una vez la

10. PARÁMETROS TÉCNICOS



NO MODIFIQUE LOS PARÁMETROS TÉCNICOS SI NO ES ESTRICTAMENTE NECESARIO. UNA MALA CONFIGURACIÓN DE ESTA SECCIÓN PUEDE PROVOCAR UN MAL FUNCIONAMIENTO DE LA BALANZA.



En el caso de visores verificados, abra el visor y cambie el interruptor de calibración a la posición CAL ON. En este caso, recuerde que romper los precintos conlleva la pérdida de la verificación.

ENTRAR Y SALIR DE LA CALIBRACIÓN

DISPLAY

DESCRIPCIÓN y SECUENCIA DE USO

LF 1

- CON EL INTERRUPTOR INTERNO EN POSICION CAL ON.
- Con el visor apagado, presione y mantenga presionada la tecla  y encendida de equipo, cuando la pantalla muestre *100 1*, suelte la tecla .

Presione la tecla  para acceder a las teclas  o  para cambiar de parámetro y la tecla  para salir del menú y el visor se reiniciará automáticamente.

CALIBRACIÓN DE PESO LF 1

DISPLAY

DESCRIPCIÓN y SECUENCIA DE USO

LF 1

La calibración se puede realizar con cualquier peso, pero el peso no debe ser inferior a 1/3 de la máxima capacidad ni nunca debe ser sobrepasada.

CAL 2

- Presione la tecla  para empezar la calibración de zero (presione  para salir de la calibración y volver al menú LF1)



150.00 kg

- Utilice ,  y , **0 ~ 9** y después  para introducir el peso con el que se hará la calibración. (Presione  para salir de la calibración y volver al menú LF1)



150.00 kg

- Sitúe el peso requerido sobre la báscula tal y cómo indica el display parpadeante.



150.00 kg

- Una vez estabilice, presione  para calibrarla. (presione ESC para salir de la calibración y volver al menú LF1).



LA CALIBRACIÓN SE TERMINARÁ Y LA BÁSCULA VOLVERÁ AL MODO DE PESAJE AUTOMÁTICAMENTE.

CONFIGURACIÓN LF2

DISPLAY

DESCRIPCIÓN Y SECUENCIA DE USO

PRIMER PASO

262 144

- VISUALIZACIÓN DE LAS CUENTAS INTERNAS
- POSIBLES VALORES DE LOS PARÁMETROS DE CONFIGURACIÓN

SEGUNDO PASO

1 0 0 0 0 1

A B C D E F

A: Sistema Métrico	0:NO	1: kg	2:T	3:g
B: Sistema Americano	0:NO	1: lb	2:lb oz	
C: otras unidades	0:NO	1: TW kg	2:HK kg	3:VISS
D: PCS	0:OFF	1: ON		
E: doble rango	0:OFF	1: multi intervalo	2:multi rango	
F: unidades de calibración		1: usar unidades métricas	2: usar unidades americanas	

Lb oz no se pueden seleccionar como unidades de calibración.

La bascula no nos dejará continuar hasta el próximo paso si hay un error durante la programación.

TERCER PASO

Después de entrar los parámetros LF2, el visor mostrará la última configuración guardada. Todos los pasos deben completarse, si no el visor continuará con la configuración anterior.

Proceda con la calibración de peso después de LF2.

- Presione la tecla  para empezar y mostrará el VALOR INTERNO. Presione  para salir del menú y la báscula se reiniciará automáticamente.

LF2



262 144



10000 1



000000kg



d 0.0kg





d 0 0 1











LF2







- Presione  para continuar con la configuración. (presione  para salir de la configuración y volver al menú LF2).

- Utilice ,  y , y después  para seleccionar las UNIDADES Y MODO DE PESAJE según la tabla anterior. (presione  para salir de la calibración y volver al menú LF2).

- Utilice ,  y , y después  para seleccionar la CAPACIDAD MÁXIMA, teniendo en cuenta el número de decimales que va a seleccionar en el siguiente paso. (presione  para salir de la calibración y volver al menú LF2).

- Utilice ,  y después  para mover el punto decimal. (presione  para salir de la configuración y volver al menú LF2).

- Utilice  y después  para cambiar el escalón (presione  para salir de la configuración y volver al menú LF2).

- Utilice ,  y  para continuar con otras configuraciones o presione  para salir del menú y la báscula se reiniciará automáticamente).

VELOCIDAD DEL CONVERTIDOR AD *LF 4*













SPEED 1 velocidad estándar 15Hz.

SPEED 2 alta velocidad 30Hz.

SPEED 3 baja velocidad 7.5Hz













*Esta función queda bloqueada cuando UF-5 se encuentra en modo HOLD 1.

*El valor de fábrica es 1

DISPLAY	DESCRIPCIÓN Y SECUENCIA DE USO
 	• Presione  para empezar o  para salir del menú y la báscula se reiniciará automáticamente.
 	• Utilice  y después  para seleccionar la velocidad del convertidor AD (presione  para salir de la configuración y volver al menú LF4)
	• Utilice  ,  y después  para continuar con otros ajustes o presione  para salir del menú y la báscula se reiniciará automáticamente.

CIEGA *LF 5*

DISPLAY	DESCRIPCIÓN Y SECUENCIA DE USO
	<p>ZP 0 OFF</p> <p>ZP 1 Una división no se mostrará estando a cero</p> <p>ZP 2 Dos divisiones no se mostrarán estando a cero</p> <p>ZP 3 Tres divisiones no se mostrarán estando a cero</p> <p>ZP 4 Cuatro divisiones no se mostrarán estando a cero</p> <p>ZP 5 Cinco divisiones no se mostrarán estando a cero</p> <p>*Esta función queda bloqueada cuando UF-5 se encuentra en modo HOLD 1</p> <p>*El valor de fábrica es ZP 0</p>

DISPLAY	DESCRIPCIÓN Y SECUENCIA DE USO
 	• Presione  para empezar o  para salir del menú y la báscula se reiniciará automáticamente.
	• Utilice  y después  para seleccionar cuantas divisiones nos e mostrarán a cero. (presione ESC para salir de la configuración y volver al menú LF4)
 	• Utilice  ,  y después  para continuar con otros ajustes o presione  para salir del menú y la báscula se reiniciará automáticamente.

CONFORMIDAD DE APROBACIÓN **LF 6**

DISPLAY

LF 6



DESCRIPCIÓN Y SECUENCIA DE USO

nonE Versión no verificada **OIML** versión verificada
NO MODIFIQUE BAJO NINGÚN CONCEPTO ESTE PARÁMETRO.

El cambio de este parámetro implica el bloqueo de ciertas funcionalidades.

GRAVEDAD **LF 7**

*Introduzca la gravedad de su zona antes de realizar la primera calibración.

*Introduzca la gravedad de destino después de realizar la calibración.

*El valor de gravedad será denegado si es mayor que 9.83217 (gravedad de polo) o inferior que 9.78031 (gravedad del ecuador).

Valor de fábrica: 9.801

DISPLAY

LF 7



--00--

9.8035



9.8035



DESCRIPCIÓN Y SECUENCIA DE USO

- Presione para continuar o para salir del menú y la báscula se reiniciará automáticamente.

- La pantalla mostrará el número de pre-calibración durante un segundo.

- Presione para continuar.

- Utilice , y , **0 ~ 9** y después para introducir el valor de gravedad.. (presione ESC para salir de la configuración y volver al menú LF 7).

CERO INICIAL **LF 8**

SEtZ Y resetea el punto de cero cada vez que se reinicia la báscula

SEtZ n reseteo del punto cero OFF

DISPLAY

LF 8



SEtZ Y



LF 8

DESCRIPCIÓN y SECUENCIA DE USO

- Presione para empezar o para salir del menú y la báscula se reiniciará automáticamente.

- Utilice y después para seleccionar el modo de cero inicial. (presione para salir de la configuración y volver al menú LF8)

- Utilice , y después para continuar con otros ajustes o presione para salir del menú y la báscula se reiniciará automáticamente.

11. GARANTÍA

Este indicador está garantizado contra todo defecto de fabricación y de material, por un periodo de 1 año a partir de la fecha de entrega.

Durante este periodo, GIROPÈS, se hará cargo de la reparación del indicador.

Esta garantía no incluye los daños ocasionados por uso indebido o sobrecargas.

La garantía no cubre los gastos de envío (portes) necesarios para la reparación del indicador.

1. SPÉCIFICATIONS

BR16

	Précision	Classe III
	Plage de sensibilité de la capteurs de charge	1.5 ~ 3.0mV/V
	Non linéarité	≤0.01%F.S
	Voltage capteurs	DC 5V
	Échelon	1/2/5 (sélectionnable)
	Fréquence d'échantillonnage	20 fois par seconde (au delà de la météorologie)
	Résolution interne	300.000~600.000

2. ALIMENTATION

BR16

	Entrée	100/240VAC
	Sortie	12V/1A
	Batterie rechargeable	6V/4Ah

3. AVANT SON UTILISATION

- 1) Placez la balance sur une surface ferme et de niveau et ne l'exposez pas à des environnements vibratoires.
- 2) Utilisez une source d'alimentation indépendante, éviter les chocs électriques.
- 3) Ne placez pas d'objets sur la plateforme au moment de la mise en marche de l'indicateur.
- 4) Laissez la balance préchauffer pendant 2-3 minutes avant utilisation.
- 5) Évitez les changements brusques de température et les courants d'air.
- 6) Évitez de surcharger la balance, ne dépassez jamais la capacité maximale.

4. CONSOMMATION

- Consommation normale au repos: environ 12mA - 333h
- Consommation avec rétroéclairage: environ 36mA - 111,11h
- Consommation avec rétroéclairage et sortie RS-232: environ 48mA-83h
- Durée de la batterie, environ 320 heures

5. CONNEXION DE LA CAPTEURS DE CHARGE À L'INDICATEUR

- 1) Le connecteur de la capteurs de charge est à 7 broches.
- 2) Lorsque l'indicateur est en marche, ne retirez pas le connecteur de la capteurs de charge, cet acte pourrait endommager l'équipement

SCHÉMA CAPTEURS À 7 BROCHES

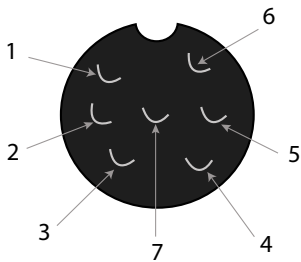
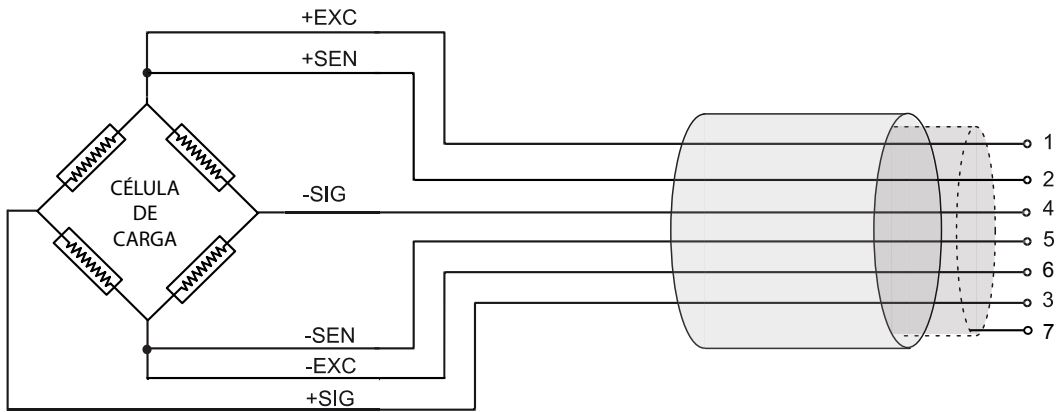

PIN 1	EXC +
PIN 2	SEN +
PIN 3	SIG +
PIN 4	SIG -
PIN 5	SEN -
PIN 6	EXC -
PIN 7	GND

CONNEXION RS232

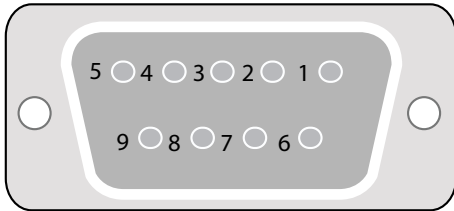

2	Tx
3	Rx
5	GND

PROTOCOLE

signal UART de EIA-RS232 C

SIGNAL UART DE EIA-RS232 C	
Sortie série	1200 / 2400 / 4800 / 9600 / 19200 / 34800 bps
Bits de données	8 bits
Bits de parité	No
Bits de stop	1 bit

INFORMATION TÊTES

Tête 1 (2 OCTETS)	Tête 2 (2 OCTETS)
OL – Surcharge	
ST – Stable	NT – Poids net
US – INSTABLE	GS – Poids brut

6. DESCRIPTION DE L'AFFICHAGE ET DU CLAVIER

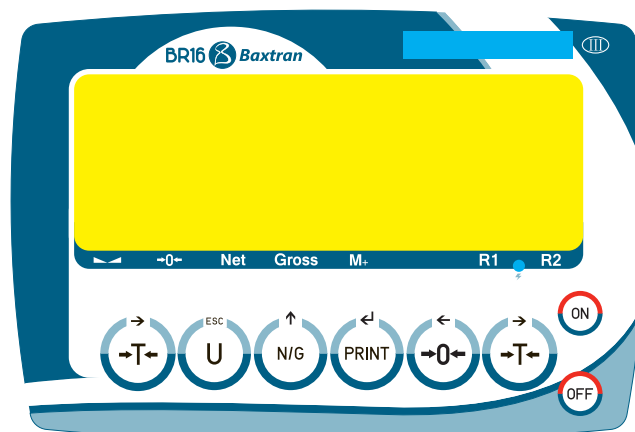

Appuyez sur cette touche pour faire mettre la balance en marche.



Maintenez cette touche appuyée pendant 2 secondes pour éteindre l'indicateur.



1ère fonction Pour changer l'unité de pesage.

2ème fonction Pour quitter un menu.



1ère fonction Pour régler l'affichage de lecture à zéro « 0 », la valeur d'affichage doit être inférieure à $\pm 2\%$ de la capacité maximale.

2ème fonction Pour déplacer un espace vers la gauche ou vers le bas dans le mode de programmation.



1ère fonction Pour soustraire le poids d'un récipient.

2ème fonction Pour déplacer un espace vers la droite ou vers le bas dans le mode de programmation.



1ère fonction Pour afficher le poids net ou brut d'un produit lorsqu'on a effectué une tare. Quand on visualise le poids brut du produit, les autres touches sont désactivées.

2ème fonction Pour augmenter les valeurs dans le mode de programmation.



1ère fonction Transmission manuelle des données via le port RS-232 à un PC ou une imprimante et selon le mode choisi.

2ème fonction Touche de confirmation dans le mode de programmation.

7. MODE COMPTE PIÈCES

- Appuyez sur la touche jusqu'à ce que l'écran affiche Pcs.
- Appuyez successivement sur pour sélectionner la quantité de pièces de l'échantillon. L'écran affichera successivement C 10 / C 20 / C 50 / C 100 / C 200.
- Placez l'échantillon sur la plateforme, attendez que l'indicateur de stabilité s'allume et appuyez sur la touche .
- Placez le produit sur la plateforme et l'écran affichera le nombre de pièces.

L'accumulation et l'envoi de données dépendront du mode sélectionné dans la section [UF-6](#).

- Pour revenir au mode de pesage normal, appuyez sur la touche .
- Si vous souhaitez revenir au mode de comptage de pièces, en utilisant le même échantillon de référence, appuyez à nouveau sur la touche .
- Si vous voulez changer l'échantillon de référence, répétez les étapes ci-dessus.

8. CONFIGURATION DE PARAMÈTRES

8.1	COMPTES INTERNES (A/D)	UF-1
8.2	CONFIGURATION DES LIMITES DE POIDS (SUPÉRIEURE ET INFÉRIEURE)	UF-2
8.3	AUTOCONNEXION AUTOMATIQUE	UF-3
8.4	CONFIGURATION DE L'ÉCLAIRAGE DE L'AFFICHAGE	UF-4
8.5	FONCTION HOLD	UF-5
8.6	SORTIE DE DONNÉES RS-232	UF-6
8.7	CONFIGURATION DE LA VITESSE RS-232	UF-7
8.8	MOYENNE DU ZÉRO	UF-8
8.9	CONFIGURATION DE LA GRAVITÉ	UF-9

Pour accéder à la configuration des paramètres, appuyez simultanément sur les touches et .

Appuyez sur les touches et pour naviguer dans le menu (UF-1 ~ UF-9).

Appuyez sur la touche pour accéder au paramètre et confirmez.

Appuyez sur la touche pour quitter le menu et revenir au mode de pesage.

8.1 COMPTES INTERNES (A/D) | UF-1

1. Appuyez sur la touche pour afficher les comptes internes de la balance.
2. Pour passer au paramètre suivant, appuyez sur la touche et l'écran indiquera la tension de la batterie.
3. Appuyez sur la touche pour revenir au menu *UF*.

8.2 CONFIGURATION DES LIMITES DE POIDS (SUPÉRIEURE ET INFÉRIEURE) | UF-2

1. Appuyez sur la touche pour accéder au paramètre.
2. L'écran affichera « 000000L » (limite inférieure).
3. Utilisez les touches et pour déplacer le curseur et la touche pour sélectionner le numéro désiré.
4. Appuyez sur la touche pour confirmer.
5. L'écran affichera « 000000H » (Limite supérieure).
6. Utilisez les touches et pour déplacer le curseur et la touche pour sélectionner le numéro désiré.
7. Appuyez sur la touche pour confirmer.
8. L'écran affichera la valeur.





A	B	C
0	0	0

 (configuration de l'alarme)

AFFICHAGE	VALEUR	STABILITÉ
A	0	pas besoin de stabilité pour sonner
	1	besoin de stabilité pour sonner
B	0	toujours 0
C	0	alarme éteinte
	1	alarme retentit s dans la bande Ok (entre limites Lo et Hi)
	2	alarme retentit si vous êtes en dessous de la limite inférieure Lo ou au-dessus de la limite supérieure Hi

LO	OK	HI
----	----	----



LO	OK	HI
----	----	----





9. Utilisez les touches  et  pour déplacer le curseur et la touche  pour sélectionner le numéro désiré.
10. Appuyer sur la touche  pour confirmer.

Les indications à l'écran **Lo**, **Ok**, **Hi** apparaîtront à l'écran selon le poids.

8.3 AUTODÉCONNEXION AUTOMATIQUE | UF-3



MODES:



	Autodéconnexion désactivée.
	Autodéconnexion activée, la balance s'éteindra automatiquement après 1 minute sans utilisation. Sélectionnez le temps d'autodéconnexion entre 1 et 99 minutes.

1. Appuyez sur la touche  pour accéder au paramètre.
2. Utilisez les touches  et  pour déplacer le curseur et la touche  pour sélectionner le temps désiré.
3. Appuyez sur la touche  pour confirmer.

8.4 CONFIGURATION DE L'ÉCLAIRAGE DE L'AFFICHAGE | UF-4



MODES:

	Automatique.
	Éclairage toujours activé.
	Éclairage désactivé.

1. Appuyez sur la touche  pour accéder au paramètre.
2. Appuyez sur la touche  pour sélectionner le mode désiré.
3. Appuyez sur la touche  pour confirmer.

8.5 FONCTION HOLD | UF-5









Les modes **HOLD** permettent, une fois l'objet retiré du plateau, que l'affichage garde le poids fixe jusqu'à appuyer à nouveau sur , fonction très utile pour le pesage des animaux. **Remarque: Si vous avez activé le mode Hold, VOUS NE POURREZ PAS UTILISER LA FONCTION LIMITE OU ACCUMULATION.**

1. Appuyez sur la touche  pour accéder au paramètre.
2. Appuyez sur la touche  pour sélectionner le mode désiré..
3. Appuyez sur la touche  pour confirmer.

MODES:



- **HOLD 0:** Désactivé.
- **HOLD 1:** Animal en mouvement.
- **HOLD 2:** Valeur de pic.
- **HOLD 3:** Hold stable.
- **HOLD 4:** Hold stable avec auto-annulation à zéro.

HOLD 1.

- Une fois que vous avez accédé à ce paramètre, l'écran affiche **Pct**,
- Utilisez les touches  et  pour déplacer le curseur et la touche  pour sélectionner la valeur de la plage HOLD désirée de 00 à 100.
- Appuyer sur la touche  pour confirmer.
- L'écran affichera **time 8**, utilisez les touches  et  pour déplacer le curseur et la touche  pour sélectionner le nombre de répétitions au cours de la plage de hold.
- Appuyer sur la touche  pour confirmer.

Exemple: Pct petits et time grand implique plus de précision et plus de temps de stabilisation.

8.6 SORTIE DE DONNÉES RS-232 | UF-6

1. Appuyez sur la touche  pour accéder au paramètre.
2. Appuyez sur la touche  pour sélectionner la vitesse de transmission désirée.
3. Appuyez sur la touche  pour confirmer.

FORMAT DES DONNÉES

Aucun format

232 0 Sortie RS-232 Désactivée

Format 1 PC

FORMAT AUTOMATIQUE DE POIDS OU PIÈCES

- 232 1** Envoi de trame, sans accumulation, quand on obtient une stabilité avec le **format 1**.
- 232 2** Envoi de trame continue avec **format 1**.
- 232 3** Envoi de trame, sans accumulation, manuel en appuyant sur la touche  avec **format 1**.

Format 2 PC

FORMAT AUTOMATIQUE DE POIDS OU PIÈCES

- 232 4** Envoi de trame, sans accumulation, quand on obtient une stabilité avec le **format 2**.
- 232 5** Envoi de trame continue avec **format 2**.
- 232 6** Envoi de trame, sans accumulation, manuel en appuyant sur la touche  avec **format 2**.

Format 3 imprimanteFORMAT AUTOMATIQUE
DE POIDS OU PIÈCES

S/N	WT/kg
0001	0.64
0002	0.70
0003	0.64

0003	1.98

S/N	WT/pcs
0001	20
0002	21
0003	45

0003	86

232 7 Envoi de trame et accumulation manuelle, en passant par zéro et en appuyant sur la touche  avec **format 3.**

0002	0.70
------	------

Si l'écran est à 0, on appuie deux fois de suite sur la touche  et la ligne totale est imprimée.

0003	1.98

Et on efface la mémoire des pesées.

Remarque : Accumulation et totalisation non disponible pour la métrologie légale.

ENVOI DE TRAME

232 8 Envoi de trame et accumulation automatique à la stabilité, en passant par 0 avec **format 3.**

0002	21
------	----

Si l'écran est à 0, on appuie deux fois de suite sur la touche  et la ligne totale est imprimée.

0003	86

Et on efface la mémoire des pesées.

Remarque : Accumulation et totalisation non disponible pour la métrologie légale.

Format 4 imprimante

FORMAT AUTOMATIQUE
DE POIDS OU PIÈCES

TICKET NO.0003
G 0.64kg
T 0.00kg
N 0.64kg

TICKET NO.0002
G 20pcs
T 0pcs
N 20pcs

TOTAL NUMBER
OF TICKETS 0003
TOTAL
NET 1.92

TOTAL NUMBER
OF TICKETS 0002
TOTAL
NET 40

REMARQUE: totalisation non disponible en métrologie légale.

ENVOI DE TRAME

232 9

Envoi de trame et accumulation manuelle en passant par zéro et en appuyant sur la touche  avec **format 4**

Si l'écran est à 0, on appuie deux fois de suite sur la touche  et le résumé des tickets est imprimé.

Et on efface la mémoire des pesées.

REMARQUE: totalisation non disponible en métrologie légale.

TICKET NO.0003
G 0.64kg
T 0.00kg
N 0.64kg

TOTAL NUMBER
OF TICKETS 0003
TOTAL
NET 1.92

ENVOI DE TRAME

232 10

Envoi de trame et accumulation automatique à la stabilité, en passant par zéro et en appuyant sur la touche  avec **format 4.**

Si l'écran est à 0, on appuie deux fois de suite sur la touche  et le résumé des tickets est imprimé.

Et on efface la mémoire des pesées.

REMARQUE: totalisation non disponible en métrologie légale.

TICKET NO.0002
G 20pcs
T 0pcs
N 20pcs

TOTAL NUMBER
OF TICKETS 0002
TOTAL
NET 40

REMARQUE: Chaque fois qu'une accumulation est terminée, le viseur affiche le total cumulé pendant 3 secondes.

FORMAT 1 (232 1 ~ 3):

18 OCTETS ASCII POUR LES UNITÉS kg, g, t, lb

1	2	,	1	2	,	1	2	3	4	5	6	7	8	1	2	CR	LF
Tête 1		Tête 2		Données								Unité					

21 OCTETS ASCII POUR LES UNITÉS tl, t, lboz

1	2	,	1	2	,	1	2	3	4	5	6	7	8	9	1	2	3	4	CR	LF
Tête 1		Tête 2		Données								Unité								

19 OCTETS ASCII POUR L'UNITÉ pcs

1	2	,	1	2	,	1	2	3	4	5	6	7	8	1	2	3	CR	LF
Tête 1		Tête 2		Données								Unité						

FORMAT 2 (232 4 ~ 6):

12 OCTETS ASCII POUR LES UNITÉS kg, g, t, lb

1	2	3	4	5	6	7	8	1	2	CR	LF
Données								Unité			

15 OCTETS ASCII POUR LES UNITÉS tl, t, lboz

1	2	3	4	5	6	7	8	9	1	2	3	4	CR	LF
Données									Unité					

13 OCTETS ASCII POUR L'UNITÉ pcs

1	2	3	4	5	6	7	8	1	2	3	CR	LF
Données								Unité				

8.7 CONFIGURATION DE LA VITESSE DU CONVERTISSEUR | UF-7 (*)

1. Appuyez sur la touche  pour accéder au paramètre.
2. Appuyez sur la touche  pour sélectionner le mode désiré.

Mode 1	Normal
Mode 2	Rapide
Mode 3	Lent

3. Appuyer sur la touche  pour confirmer.

8.8 ZÉRO AVEUGLE | UF-8 (*)

Affiche 0 jusqu'à atteindre la prochaine division sélectionnée. En commençant à afficher des valeurs à partir de cette division.

Exemple:





balance avec e=2g

aveugle en 5 divisions

Il affichera 0 jusqu'à atteindre 2x5 = 10g la première valeur qui sera affichée sera 12g.

1. Appuyez sur la touche  pour accéder au paramètre.
2. Appuyez sur la touche  pour sélectionner.
3. Appuyez sur la touche  pour confirmer.

8.9 CONFIGURATION DE LA GRAVITÉ | UF-9 (*)

1. Appuyez sur la touche  pour accéder au paramètre.
2. Pour modifier la valeur, appuyez sur la touche , puis utilisez les touches, utilisez les touches  et  pour déplacer le curseur et la touche pour sélectionner le numéro désiré.

9. ÉTALONNAGE (UNIQUEMENT POUR LE PERSONNEL AUTORISÉ) (*)



9.1	ÉTALONNAGE DE ZÉRO+POIDS (PORTÉE)	ECF-1
9.2	ÉTALONNAGE DE ZÉRO	ECF-2
9.3	ÉTALONNAGE DE POIDS (PORTÉE)	ECF-3

0. Déplacer le switch interne sur CAL ON.

1. Dans le mode de pesage normal, appuyez sur les touches  et , l'écran affichera le message **ECF – 1**.

2. Appuyez sur les touches  et  pour sélectionner la fonction désirée: **ECF-1, ECF-2 o ECF-3**

9.1 ÉTALONNAGE DE ZÉRO+POIDS | ECF-1

Appuyez sur la touche , l'écran affichera CALZ.

Appuyez sur la touche , pour mettre à zéro la lecture de l'affichage.

Appuyez sur les touches  et  pour déplacer le curseur

Appuyez sur la touche  introduire la valeur du poids d'étalonnage.

Placez le poids d'étalonnage sur la plateforme et appuyez sur la touche  pour effectuer l'étalonnage une fois que la lecture est stable.

9.2 ÉTALONNAGE DE ZÉRO | ECF-2

Appuyez sur la touche , l'écran affichera CALZ.

Appuyez sur la touche , pour mettre la lecture de l'affichage à zéro.

Appuyez sur la touche , pour effectuer l'étalonnage.

9.3 ÉTALONNAGE DE POIDS | ECF-3

Appuyez sur la touche , l'écran affichera la valeur du poids d'étalonnage.

Appuyez sur les touches  et  pour déplacer le curseur.

Appuyez sur la touche  pour modifier la valeur du poids d'étalonnage.

Appuyez sur la touche , pour confirmer.

Placez le poids d'étalonnage sur la plateforme et appuyez sur la touche  pour effectuer l'étalonnage une fois que la lecture est stable.

10. PARAMÈTRES TECHNIQUES









NE MODIFIER LES PARAMÈTRES TECHNIQUES QUE SI CELA EST STRICTEMENT NÉCESSAIRE. UNE MAUVAISE CONFIGURATION DE CETTE SECTION PEUT PROVOQUER UN MAUVAIS FONCTIONNEMENT DE LA BALANCE.

















Dans le cas de viseurs vérifié, ouvrez l'écran et changez l'interrupteur d'étalonnage à la position ON. Dans ce cas, rappelez-vous que de briser

les joints d'étanchéité implique la perte de la vérification.

























ENTRER DANS ET QUITTER L'ÉTALONNAGE

ÉCRAN	DESCRIPTION ET SÉQUENCE D'UTILISATION
	<ul style="list-style-type: none"> • AVEC INTERRUPTEUR INTERNE EN POSITION CAL ON. • Avec le viseur éteint, appuyez et maintenez la touche  appuyée et sous tension lorsque l'écran affiche <i>100 !</i>, relâchez la touche .
	<p>Appuyez sur la touche  pour accéder aux touches  ou  pour modifier le paramètre et la touche  pour quitter le menu et le viseur redémarrera automatiquement.</p>

ÉTALONNAGE DE POIDS LF 1

ÉCRAN	DESCRIPTION ET SÉQUENCE D'UTILISATION
	L'étalonnage peut être effectué avec n'importe quel poids, mais le poids ne doit pas être inférieur à 1/3 de la capacité maximale ou ne doit jamais être dépassé.
 	• Appuyez sur la touche  pour démarrer l'étalonnage du zéro (appuyez sur  pour quitter l'étalonnage et revenir au menu LF1)
 	• Utilisez  ,  et  , 0 ~ 9 puis  pour entrer le poids avec lequel sera fait l'étalonnage. (Appuyez sur  pour quitter l'étalonnage et revenir au menu LF1)
 	• Placez le poids requis sur la balance, comme indiqué par l'affichage clignotant.
 	• Une fois établi, appuyez sur  p'étalonner. (appuyez sur ESC pour quitter l'étalonnage et revenir au menu LF1).
	L'ÉTALONNAGE SE TERMINERA ET LA BALANCE REPASSERA AUTOMATIQUÉMENT AU MODE DE PESAGE.

CONFIGURATION LF2

ÉCRAN	DESCRIPTION ET SÉQUENCE D'UTILISATION																														
PREMIÈRE ÉTAPE																															
262 144	<ul style="list-style-type: none"> • VISUALISATION DES COMPTES INTERNES • POSSIBLES VALEURS DES PARAMÈTRES DE CONFIGURATION 																														
<table border="1"> <tr> <td>A: Système métrique</td> <td>0:NO</td> <td>1: kg</td> <td>2:T</td> <td>3:g</td> </tr> <tr> <td>B: Système américain</td> <td>0:NO</td> <td>1: lb</td> <td colspan="2">2:lb oz</td> </tr> <tr> <td>C: autres unités</td> <td>0:NO</td> <td>1: TW kg</td> <td>2:HK kg</td> <td>3:VISS</td> </tr> <tr> <td>D: PCS</td> <td>0:OFF</td> <td>1: ON</td> <td colspan="2"></td> </tr> <tr> <td>E: double plage</td> <td>0:OFF</td> <td>1: multi intervalle</td> <td colspan="2">2: multi plage</td> </tr> <tr> <td>F: unités d'étalonnage</td> <td></td> <td>1: utilise unité métriques</td> <td colspan="2">2: utiliser unités américaines</td> </tr> </table>		A: Système métrique	0:NO	1: kg	2:T	3:g	B: Système américain	0:NO	1: lb	2:lb oz		C: autres unités	0:NO	1: TW kg	2:HK kg	3:VISS	D: PCS	0:OFF	1: ON			E: double plage	0:OFF	1: multi intervalle	2: multi plage		F: unités d'étalonnage		1: utilise unité métriques	2: utiliser unités américaines	
A: Système métrique	0:NO	1: kg	2:T	3:g																											
B: Système américain	0:NO	1: lb	2:lb oz																												
C: autres unités	0:NO	1: TW kg	2:HK kg	3:VISS																											
D: PCS	0:OFF	1: ON																													
E: double plage	0:OFF	1: multi intervalle	2: multi plage																												
F: unités d'étalonnage		1: utilise unité métriques	2: utiliser unités américaines																												
<p>lb oz ne peuvent être sélectionné comme unités d'étalonnage.</p> <p>La balance ne nous laissera pas passer à l'étape suivante s'il y a une erreur lors de la programmation.</p>																															
TROISIÈME ÉTAPE																															
<p>Après avoir entré les paramètres LF2, l'écran affichera la dernière configuration enregistrée. Toutes les étapes doivent être remplies, sinon l'affichage se poursuivra avec la configuration précédente.</p> <p>Continuez l'étalonnage du poids après LF2.</p>																															
LF2	<ul style="list-style-type: none"> • Appuyez sur la touche  pour démarrer et cela affichera VALEUR INTERNE. Appuyez sur  pour quitter le menu et la balance sera automatiquement réinitialisée. 																														
262 144	<ul style="list-style-type: none"> • Appuyez sur  pour continuer la configuration. (appuyez sur  pour quitter la configuration et revenir au menu LF2). 																														
10000 1	<ul style="list-style-type: none"> • Utilisez ,  et  et  pour sélectionner les UNITÉS ET LE MODE DE PESAGE selon le tableau ci-dessus. (appuyez sur  pour quitter l'étalonnage et revenir au menu LF2). 																														
0000000 kg	<ul style="list-style-type: none"> • Utilisez ,  et , et  pour sélectionner CAPACITÉ MAXIMALE, en prenant en compte le nombre de décimales à sélectionner à l'étape suivante. (appuyez sur  pour quitter l'étalonnage et revenir au menu LF2) 																														
d 0.0 kg	<ul style="list-style-type: none"> • Utilisez ,  et  pour déplacer le point décimal. (appuyez sur  pour quitter la configuration et revenir au menu LF2). 																														
d 0.0 01	<ul style="list-style-type: none"> • Utilisez  et  pour changer l'échelon (appuyez sur  pour quitter la configuration et revenir au menu LF2). 																														
LF2	<ul style="list-style-type: none"> • Utilisez ,  et  pour continuer avec d'autres configurations ou appuyez sur  pour quitter le menu et la balance sera automatiquement réinitialisée). 																														

VITESSE DU CONVERTISSEUR AD LF 4

SPEED 1 vitesse standard 15Hz.

SPEED 2 vitesse élevée 30Hz.

SPEED 3 vitesse basse 7.5Hz

*Cette fonction est bloquée lorsque UF-5 est en mode HOLD 1.

*La valeur d'usine est 1.

ÉCRAN**DESCRIPTION ET SÉQUENCE D'UTILISATION**

LF4



• Appuyez sur pour démarrer ou sur pour quitter le menu et la balance redémarrera automatiquement.

SPEED 1



• Utilisez puis pour sélectionner la vitesse du convertisseur AD (appuyez sur pour quitter la configuration et revenir au menu LF4).

LF4

• Utilisez , et pour continuer avec d'autres réglages ou appuyez sur pour quitter le menu et la balance sera automatiquement réinitialisée.

AVEUGLE LF 5**ÉCRAN****DESCRIPTION ET SÉQUENCE D'UTILISATION**

LF5

ZP 0 OFF.

ZP 1 Une division ne sera pas affichée en étant sur zéro.

ZP 2 Deux divisions ne seront pas affichées en étant sur zéro.

ZP 3 Trois divisions ne seront pas affichées en étant sur zéro.

ZP 4 Quatre divisions ne seront pas affichées en étant sur zéro.

ZP 5 Cinq divisions ne seront pas affichées en étant sur zéro.

*Cette fonction est bloquée lorsque UF-5 est en mode HOLD 1.

*La valeur d'usine est ZP 0.

ÉCRAN**DESCRIPTION ET SÉQUENCE D'UTILISATION**

LF5



• Appuyez sur pour démarrer ou sur pour quitter le menu et la balance redémarrera automatiquement.

ZP 0



• Utilisez et pour sélectionner le nombre de divisions qui seront affichées sur zéro. (appuyez sur **ESC** pour quitter la configuration et revenir au menu LF4)

LF5

• Utilisez , et pour continuer avec d'autres réglages ou appuyez sur pour quitter le menu et la balance sera automatiquement réinitialisée.

CONFORMITÉ D'APPROBATION LF 6

DISPLAY

DESCRIPTION ET SÉQUENCE D'UTILISATION

LF 6

nonE Version non vérifiée OIML version vérifiée
NE MODIFIER EN AUCUN CAS CE PARAMÈTRE.

La modification de ce paramètre implique le blocage de certaines fonctionnalités.



GRAVITÉ LF 7

*Entrez la gravité de votre région avant de réaliser le premier étalonnage.

*Entrez la gravité de destination avant de réaliser l'étalonnage.

*La valeur de la gravité sera refusée si supérieure à 9,83217 (gravité de pôle) ou inférieure à 9,78031 (gravité de l'Équateur).

Valeur d'usine: 9.801

ÉCRAN

DESCRIPTION ET SÉQUENCE D'UTILISATION

LF 7

- Appuyez sur  pour continuer ou sur  pour quitter le menu et la balance redémarrera automatiquement.



-00-

- L'écran affichera le nombre de pré-étalonnages pendant une seconde.

9.8035

- Appuyez sur  pour continuer.



9.8035

- Utilisez ,  et , 0 ~ 9 et  pour introduire la valeur de gravité. (appuyez sur ESC pour quitter la configuration et revenir au menu LF 7).



ZÉRO INITIAL LF 8

SEtZ Y remet à zéro le point zéro à chaque fois que la balance est réinitialisée

SEtZ n remet à zéro le point zéro OFF

ÉCRAN

DESCRIPTION ET SÉQUENCE D'UTILISATION

LF 8

- Appuyez sur  pour démarrer ou sur  pour quitter le menu et la balance redémarrera automatiquement.







SEtZ Y

- Utilisez ,  et  pour sélectionner le mode zéro initial. (appuyez sur  pour quitter la configuration et revenir au menu LF8)



LF 8

- Utilisez ,  et  pour continuer avec d'autres réglages ou appuyez sur  pour quitter le menu et la balance sera automatiquement réinitialisée.

11. GARANTIE

Cet indicateur est garanti contre les défauts de fabrication et de matériaux pour une période de 1 an à compter de la date de livraison. Durant cette période, Giropès, se chargera de la réparation de l'indicateur. Cette garantie ne couvre pas les dommages causés par une mauvaise utilisation ou une surcharge. La garantie ne couvre pas les frais d'expédition (fret) nécessaires à la réparation de l'indicateur.

1. SPECIFICHE

BR16

Precisione	Classe III
Intervallo di sensibilità della cella di carico	1,5 ~ 3,0 mV/V
Non linearità	0,01%F.S
Voltaggio cella	CC 5V
Gradino	1/2/5 (selezionabile)
Frequenza di campionamento	20 volte al secondo (al di fuori della metrologia)
Risoluzione interna	300.000-600.000

2. ALIMENTAZIONE

BR16

Ingresso	100/240V CA
Uscita	12V/1A
Batteria ricaricabile	6V/4Ah

3. PRIMA DELL'USO

- 1) Situare la bilancia su una superficie piana e stabile, non esporla ad ambienti con vibrazioni.
- 2) Utilizzare una sorgente elettrica indipendente, evitare perturbazioni elettriche.
- 3) Durante l'avvio dell'indicatore, non collocare nessun oggetto sulla piattaforma.
- 4) Prima di utilizzare la bilancia, consentirne il preriscaldamento per 2-3 minuti.
- 5) Evitare bruschi cambi di temperatura e correnti d'aria.
- 6) Non sovraccaricare mai la bilancia né superare la capacità massima.

4. CONSUMO

- Consumo normale a riposo: 12mA - 333h ca.
- Consumo con la retroilluminazione: 36mA - 111,11h ca.
- Consumo con la retroilluminazione e uscita RS-232: 48mA-83h ca.
- Durata della batteria: senza la retroilluminazione, 320 ore ca.

5. COLLEGAMENTO DELLA CELLA DI CARICO ALL'INDICATORE

- 1) Il connettore della cella di carico è a 7 pin.
- 2) Quando l'indicatore è in funzione, non scollegare il connettore dalla cella di carico perché questo potrebbe danneggiare l'apparecchiatura.

SCHEMA DELLA CELLA A 7 PIN

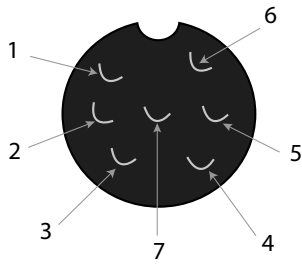
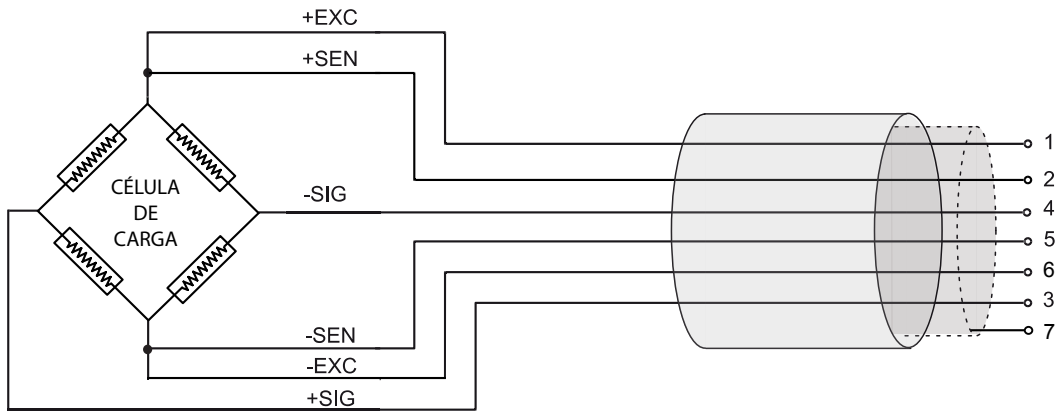

PIN 1	EXC +
PIN 2	SEN +
PIN 3	SIG +
PIN 4	SIG -
PIN 5	SEN -
PIN 6	EXC -
PIN 7	GND

COLLEGAMENTO RS232

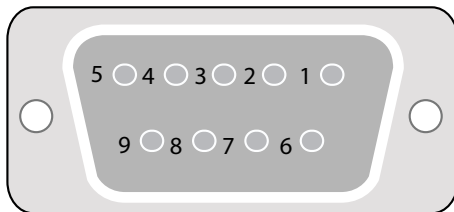

2	Tx
3	Rx
5	GND

PROTOCOLLO

UART signal of EIA-RS232 C

SEGNALE UART DI EIA-RS232 C	
Uscita serie	1200 / 2400 / 4800 / 9600 / 19200 / 34800 bps
Bit di dati	8 bits
BIT DI PARITÀ	No
Bit di stop	1 bit

INFORMAZIONI INTESTAZIONI

Intestazione 1 (2 BYTE)	Intestazione 2 (2 BYTE)
OL – Sovraccarico	
ST – Stabile	NT – Peso netto
US – INSTABILE	GS – Peso lordo

6. DESCRIZIONE DEL DISPLAY E DELLA TASTIERA

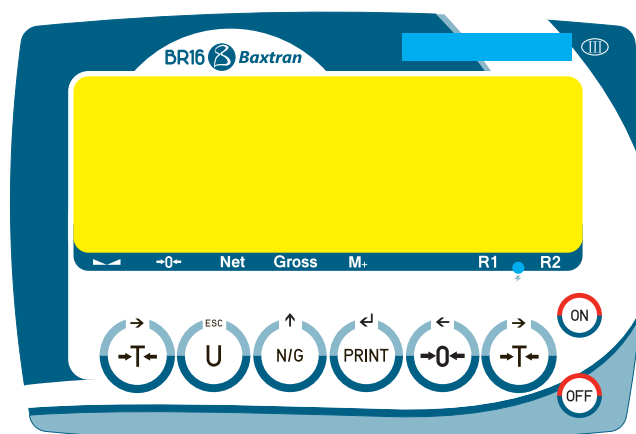

Per accendere la bilancia, premere questo tasto.



Per spegnere l'indicatore, mantenere premuto questo tasto per 2 secondi.



1 funzione Per cambiare l'unità di pesatura.

2 funzione Per uscire da un menu.



1 funzione

Per mettere la lettura del display sullo zero "0", il valore del display deve essere inferiore a $\pm 2\%$ della capacità massima.

2 funzione Per spostarsi di uno spazio verso sinistra o verso il basso in modalità di programmazione.



1 funzione Per sottrarre il peso di un contenitore.

2 funzione Per spostarsi di uno spazio verso destra o verso l'alto in modalità di programmazione.



1 funzione

Per visualizzare il peso netto o lordo di un prodotto quando è stata realizzata una Tara. Quando si visualizza il peso lordo del prodotto, gli altri tasti sono disattivati.

2 funzione Per aumentare i valori in modalità di programmazione.





1 funzione



Trasmissione manuale di dati mediante la porta RS-232 a un PC o una stampante e secondo la modalità scelta.

2 funzione Tasto di conferma in modalità di programmazione.

7. MODALITÀ CONTAPEZZI

1. Premere il tasto  affinché lo schermo non visualizza Pcs.
2. Premere  successivamente per selezionare la quantità di pezzi del campione. Lo schermo visualizzerà successivamente C 10 / C 20 / C 50 / C 100 / C 200.
3. Porre il campione sulla piattaforma, aspettare che si accenda l'indicatore di stabilità e premere il tasto .
4. Collocare il prodotto sopra la piattaforma e lo schermo visualizzerà il numero di pezzi.

L'accumulo e l'invio dei dati dipenderà dalla modalità scelta nel paragrafo [UF-6](#).

- Per tornare alla modalità di pesatura normale, premere il tasto .
- Per tornare alla modalità contapezzi, usando lo stesso campione di riferimento, premere nuovamente il tasto .
- Per modificare il campione di riferimento, ripetere i passaggi descritti precedentemente

8. CONFIGURAZIONE DEI PARAMETRI

8.1	CALCOLI INTERNI (A/D)	<i>UF-1</i>
8.2	CONFIGURAZIONE DEI LIMITI DI PESO (SUPERIORE E INFERIORE)	<i>UF-2</i>
8.3	DISATTIVAZIONE AUTOMATICA	<i>UF-3</i>
8.4	CONFIGURAZIONE DELL'ILLUMINAZIONE DEL DISPLAY	<i>UF-4</i>
8.5	FUNZIONE HOLD	<i>UF-5</i>
8.6	USCITA DEI DATI RS-232	<i>UF-6</i>
8.7	CONFIGURAZIONE DELLA VELOCITÀ RS-232	<i>UF-7</i>
8.8	MEDIA DELLO ZERO	<i>UF-8</i>
8.9	CONFIGURAZIONE DELLA GRAVITÀ	<i>UF-9</i>



Per accedere alla configurazione dei parametri, premere contemporaneamente i tasti  e .

Premere i tasti  e  per navigare nel menu (UF-1 ~ UF-9).









Premere il tasto  per accedere al parametro e confermare.

Premere il tasto  per uscire dal menu e tornare alla modalità di pesatura.

8.1 CALCOLI INTERNI (A/D) | *UF-1*

1. Premere il tasto  per visualizzare i calcoli interni della bilancia.
2. Per passare al parametro seguente, premere il tasto  e lo schermo indicherà il voltaggio della batteria.
3. Premere il tasto  per tornare al menu *UF*.

8.2 CONFIGURAZIONE DEI LIMITI DI PESO (SUPERIORE E INFERIORE) | *UF-2*

1. Premere il tasto  per accedere al parametro.
2. Il display visualizzerà il messaggio "00000L" (Limite inferiore).
3. Utilizzare i tasti  e  per spostare il cursore e il tasto  per selezionare il numero desiderato.
4. Premere il tasto  per confermare.
5. Il display visualizzerà "00000H" (Limite superiore).
6. Utilizzare i tasti  e  per muovere il cursore e il tasto  per selezionare il numero desiderato.
7. Premere il tasto  per confermare.
8. Il display visualizzerà il valore

A B C
0 0 0

(configurazione dell'allarme)

DISPLAY	VALOR	STABILITÀ	
A	0	non serve stabilità per suonare	
	1	serve stabilità per suonare	
B	0	sempre 0	
C	0	allarme spento	
	1	1 l'allarme suona se è nella fascia Ok (tra i limiti Ok (límites Entre Lo y Hi)	
	2	l'allarme suona se è sotto il limite inferiore Lo od oltre il limite superiore Hi	



9. Utilizzare i tasti  e  per muovere il cursore e il tasto  per selezionare il numero desiderato.

10. Premere il tasto  per confermare.

Le indicazioni sullo schermo **Lo**, **Ok**, **Hi** appariranno sullo schermo secondo il peso.

8.3 DISATTIVAZIONE AUTOMATICA | UF-3

MODALITÀ:

	Disattivazione automatica disabilitata.
	Disattivazione automatica abilitata, la bilancia si spegnerà automaticamente dopo 1 minuto-senza essere utilizzata. Selezionare il tempo di disattivazione automatica tra 1 e 99 minuti.



1. Premere il tasto  per accedere al parametro.

2. Utilizzare i tasti  e  per spostare il cursore e il tasto  per selezionare il tempo desiderato.

3. Premere il tasto  per confermare.

8.4 CONFIGURAZIONE DELL'ILLUMINAZIONE DEL DISPLAY | UF-4

MODALITÀ:

	Automatica.
	Illuminazione sempre attivata.
	Illuminazione disattivata.

1. Premere il tasto  per accedere al parametro.

2. Premere il tasto  per selezionare la modalità desiderata.

3. Premere il tasto  per confermare.

8.5 FUNZIONE HOLD | UF-5

La modalità **HOLD** fa in modo che, una volta ritirato l'oggetto dal piatto, il display mantenga il peso fissato fino alla pressione di  (funzione , molto utile per la pesatura di animali). **Nota: se è attivata la modalità hold, NON SARÀ POSSIBILE UTILIZZARE LE FUNZIONI LIMITI O ACCUMULO.**

1. Premere il tasto  per accedere al parametro.









2. Premere il tasto  per selezionare la modalità desiderata.

3. Premere il tasto per  confermare.

MODALITÀ:



- **HOLD 0** : Disattivata
- **HOLD 1** : Animale in movimento.
- **HOLD 2** : Valore di picco.
- **HOLD 3** : Hold stabile.
- **HOLD 4** : Hold stabile con autocancellazione a zero.

HOLD 1.

- Dopo aver acceduto a questo parametro, lo schermo visualizza **Pct**,
- Utilizzare i tasti  e  per spostare il cursore e il tasto  per selezionare il valore dell'intervallo di HOLD desiderato da 001 a 100.
- Premere il tasto  per confermare.
- Lo schermo visualizzerà **time 8**, utilizzare i tasti  e  per spostare il cursore e il tasto  per selezionare il numero di ripetizioni desiderato durante l'intervallo di hold.
- Premere il tasto  per confermare.

Esempio: Pct piccolo e time grande implicano una precisione e un tempo di stabilizzazione maggiori.

8.6 USCITA DEI DATI RS-232 | UF-6

1. Premere il tasto  per accedere al parametro.
2. Premere il tasto  per selezionare la velocità di trasmissione desiderata.
3. Premere il tasto  per confermare.

FORMATO DEI DATI

Nessun formato

232 0 Uscita RS-232 Disattivata

Formato 1 PC

FORMATO AUTOMATICO DI PESO O PEZZI

ST,GS,+0003. 58 kg <CR><LF>

ST,GS,+0000250pcs <CR><LF>

232 1 Invio di frame, senza accumulo, quando raggiunge la stabilità con **formato 1**.

232 2 Invio di frame continuo con **formato 1**.

232 3 Invio di frame, senza accumulo, manuale premendo il tasto  con **formato 1**.

Formato 2 PC

FORMATO AUTOMATICO DI PESO O PEZZI

+0000.64kg<CR><LF>

+0000100pcs<CR><LF>

232 4 Invio di frame, senza accumulo, quando raggiunge la stabilità con **formato 2**.

232 5 Invio di frame continuo con **formato 2**.

232 6 Invio di frame, senza accumulo, manuale premendo il tasto  con **formato 2**.

Formato 3 stampante

FORMATO AUTOMATICO DI PESO O PEZZI

S/N	WT/kg	S/N	WT/pcs
0001	0.64	0001	20
0002	0.70	0002	21
0003	0.64	0003	45
-----		-----	
0003	1.98	0003	86

232 7 Invio di frame e accumulo manuale, passando per zero e premendo il tasto  con **formato 3**.

0002 0.70

Con lo schermo a 0, se si preme due volte consecutive il tasto  si stampa la linea del totale.

0003 1.98

E si cancellano le pesature in memoria. .

INVIO DI FRAME

Nota: Accumulo e totale non disponibili per metrologia legale.

232 8 Invio di frame e accumulo automatico alla stabilità, passando per 0 con **formato 3**.

0002 21

Con lo schermo a 0, se si preme due volte consecutive il tasto  si stampa la linea del totale.

0003 86

E si cancellano le pesature in memoria.

Nota: Accumulo e totale non disponibili per metrologia legale.

Formato 4 stampante

FORMATO AUTOMATICO
DI PESO O PEZZI

TICKET NO.0003	
G	0.64kg
T	0.00kg
N	0.64kg
TOTAL NUMBER OF TICKETS 0003	
TOTAL	
NET	1.92

TICKET NO.0002	
G	20pcs
T	0pcs
N	20pcs
TOTAL NUMBER OF TICKETS 0002	
TOTAL	
NET	40

N.B: totale non disponibile in metrologia legale.

INVIO DI FRAME

232 9

Invio di frame e accumulo manuale, passando per zero e premendo il tasto  con **formato 4**

Con lo schermo a 0, se si preme due volte consecutive il tasto si  stampa il riassunto degli scontrini. e si cancellano le pesature in memoria.

N.B: totale non disponibile in metrologia legale.

TICKET NO.0003	
G	0.64kg
T	0.00kg
N	0.64kg

TOTAL NUMBER OF TICKETS 0003	
TOTAL	
NET	1.92

INVIO DI FRAME

232 10

Invio di frame e accumulo automatico alla stabilità, passando per zero e premendo il tasto  con **formato 4.**

Con lo schermo a 0, se si preme due volte consecutive il tasto si  stampa il riassunto degli scontrini.

E si cancellano le pesature in memoria.

N.B: totale non disponibile in metrologia legale.

TICKET NO.0002	
G	20pcs
T	0pcs
N	20pcs

TOTAL NUMBER OF TICKETS 0003	
TOTAL	
NET	1.92

N.B: Ogni volta che viene effettuato un accumulo, lo schermo visualizza il totale accumulato per 3 secondi.

FORMATO 1 (232 1 ~ 3):

18 BYTES ASCII PER LE UNITÀ kg, g, t, lb

1	2	,	1	2	,	1	2	3	4	5	6	7	8	1	2	CR	LF
Intestazione 1			Intestazione 2			Dati								Unità			

21 BYTES ASCII PER LE UNITÀ tl, T, lboz

1	2	,	1	2	,	1	2	3	4	5	6	7	8	9	1	2	3	4	CR	LF
Intestazione 1			Intestazione 2			Dati									Unità					

19 BYTES ASCII PER LE UNITÀ pcs

1	2	,	1	2	,	1	2	3	4	5	6	7	8	1	2	3	CR	LF
Intestazione 1			Intestazione 2			Dati								Unità				

FORMATO 2 (232 4 ~ 6):

12 BYTES ASCII PER LE UNITÀ kg, g, t, lb

1	2	3	4	5	6	7	8	1	2	CR	LF
Dati								Unità			



15 BYTES ASCII PER LE UNITÀ tl, T, lboz

1	2	3	4	5	6	7	8	9	1	2	3	4	CR	LF
Dati									Unità					

13 BYTES ASCII PER LE UNITÀ pcs

1	2	3	4	5	6	7	8	1	2	3	CR	LF
Dati								Unità				

8.7 CONFIGURAZIONE DELLA VELOCITÀ DEL CONVERTITORE | UF-7 (*)

1. Premere il tasto  per accedere al parametro.
2. Premere il tasto  per selezionare la modalità desiderata.

Modalità 1 Normale

Modalità 2 Rapida

Modalità 3 Lenta

3. Premere il tasto  per confermare.

8.8 CIECA ZERO | UF-8 (*)

Mostra 0 sullo schermo fino ad arrivare alla seguente suddivisione selezionata. Inizia a mostrare i valori a partire da questa suddivisione.

Esempio:





bilancia con e=2g

cieca su 5 suddivisioni

Mostrerà 0 fino ad arrivare a 2x5=10g, il primo valore che mostrerà sarà 12g.

1. Premere il tasto  per accedere al parametro.
2. Premere il tasto  per selezionare.
3. Premere il tasto  per confermare.

8.9 CONFIGURAZIONE DELLA GRAVITÀ | *UF-9* (*)

1. Premere il tasto  per accedere al parametro.
2. Per modificare il valore, premere il tasto , quindi utilizzare i tasti, utilizzare i tasti  e  per spostare il cursore e il tasto per selezionare il numero desiderato.

9. CALIBRAZIONE (SOLO PER IL PERSONALE AUTORIZZATO) (*)



9.1	CALIBRAZIONE DELLO ZERO + PESO (SPAN)	<i>ECF-1</i>
9.2	CALIBRAZIONE DELLO ZERO	<i>ECF-2</i>
9.3	CALIBRAZIONE DEL PESO (SPAN)	<i>ECF-3</i>

0. Spostare lo switch interno su CAL ON.

1. Nella modalità normale di pesatura, premere i tasti  e , il display visualizzerà il messaggio **ECF-1**.
2. Premere i tasti  e  per selezionare la funzione desiderata: **ECF-1, ECF-2 o ECF-3**

9.1 CALIBRAZIONE DELLO ZERO + PESO | *ECF-1*

Premere il tasto , il display visualizzerà CALZ.

Premere il tasto , per azzerare la lettura del display.

Premere i tasti  e  per spostare il cursore.

Premere il tasto , per inserire il valore del peso di calibrazione.

Collocare il peso di calibrazione sulla piattaforma e premere il tasto  per effettuare la calibrazione quando la lettura sarà stabile.

9.2 CALIBRAZIONE DELLO ZERO | *ECF-2*

Premere il tasto , il display visualizzerà CALZ.

Premere il tasto , per azzerare la lettura del display.

Premere il tasto , per effettuare la calibrazione.

9.3 CALIBRAZIONE DEL PESO | *ECF-3*

Premere il tasto , il display visualizzerà il valore del peso di calibrazione.

Premere il tasto  e  per spostare il cursore.

Premere il tasto , per modificare il valore del peso di calibrazione.

Premere il tasto , per confermare.

Collocare il peso di calibrazione sulla piattaforma e premere il tasto  per effettuare la calibrazione quando la lettura sarà stabile.

10. PARAMETRI TECNICI



NON MODIFICARE I PARAMETRI TECNICI SE NON È STRETTAMENTE NECESSARIO. UNA ERRATA CONFIGURAZIONE DI QUESTA SEZIONE PUÒ PROVOCARE UN MALFUNZIONAMENTO DELLA BILANCIA.

In caso di schermi collaudati, aprire lo schermo e spostare l'interruttore di calibrazione nella posizione CAL ON. In tal caso, è opportuno ricordare che la rottura dei sigilli comporta la perdita del collaudo.

ENTRARE E USCIRE DALLA CALIBRAZIONE





DISPLAY

DESCRIZIONE E SEQUENZA D'USO

LF 1

• CON L'INTERRUTTORE INTERNO IN POSIZIONE CAL ON.

• Con lo schermo spento, tenere premuto il tasto  e accensione di apparecchiatura; quando lo schermo mostra **100 !**, rilasciare il tasto .

Premere il tasto  per accedere ai tasti  o  per cambiare parametro e il tasto per uscire dal  menu e lo schermo si riavvierà automaticamente.

CALIBRAZIONE DEL PESO LF 1

DISPLAY

DESCRIZIONE E SEQUENZA D'USO

LF 1

La calibrazione può essere effettuata con qualsiasi peso, ma il peso non deve essere inferiore a 1/3 della capacità massima e quest'ultima non deve essere mai superata.

• Premere il tasto  per iniziare la calibrazione dello zero (premere  per uscire dalla calibrazione e tornare al men LF1)

CAL Z



150.00 kg

• Utilizzare ,  e , **0 ~ 9** e quindi  per inserire il peso con cui verrà effettuata la calibrazione. (Premere  per uscire dalla calibrazione e tornare al menu LF1)



150.00 kg



• Collocare il peso richiesto sulla bilancia nel modo indicato sul display lampeggiante.

150.00 kg



• Una volta stabilizzato, premere  per calibrarla. (premere ESC per uscire dalla calibrazione e tornare al menu LF1).

LA CALIBRAZIONE TERMINERÀ E LA BASCULA TORNERÀ AUTOMÁTICAMENTE ALLA MODALITÀ DI PESATURA.



CONFIGURAZIONE *LF2*

DISPLAY	DESCRIZIONE E SEQUENZA D'USO																														
PRIMO PASSAGGIO	<ul style="list-style-type: none"> VISUALIZZAZIONE DEI CALCOLI INTERNI POSSIBILI VALORI DEI PARAMETRI DI CONFIGURAZIONE 																														
262 144	<table border="1"> <tr> <td>A: Sistema metrico</td> <td>0:NO</td> <td>1: kg</td> <td>2:T</td> <td>3:g</td> </tr> <tr> <td>B: Sistema americano</td> <td>0:NO</td> <td>1: lb</td> <td>2:lb oz</td> <td></td> </tr> <tr> <td>C: Altre unità</td> <td>0:NO</td> <td>1: TW kg</td> <td>2:HK kg</td> <td>3:VISS</td> </tr> <tr> <td>D: PCS</td> <td>0:OFF</td> <td>1: ON</td> <td></td> <td></td> </tr> <tr> <td>E: Doppio range</td> <td>0:OFF</td> <td>1: multi intervallo</td> <td>2:multi range</td> <td></td> </tr> <tr> <td>F: Unità di calibrazione</td> <td></td> <td>1: usare unità metriche</td> <td>2: usare unità americane</td> <td></td> </tr> </table>	A: Sistema metrico	0:NO	1: kg	2:T	3:g	B: Sistema americano	0:NO	1: lb	2:lb oz		C: Altre unità	0:NO	1: TW kg	2:HK kg	3:VISS	D: PCS	0:OFF	1: ON			E: Doppio range	0:OFF	1: multi intervallo	2:multi range		F: Unità di calibrazione		1: usare unità metriche	2: usare unità americane	
A: Sistema metrico	0:NO	1: kg	2:T	3:g																											
B: Sistema americano	0:NO	1: lb	2:lb oz																												
C: Altre unità	0:NO	1: TW kg	2:HK kg	3:VISS																											
D: PCS	0:OFF	1: ON																													
E: Doppio range	0:OFF	1: multi intervallo	2:multi range																												
F: Unità di calibrazione		1: usare unità metriche	2: usare unità americane																												
SECONDO PASSAGGIO																															
1 0 0 0 0 1																															
A B C D E F																															
TERZO PASSAGGIO																															
LF2	<ul style="list-style-type: none"> Dopo avere inserito i parametri LF2, lo schermo visualizzerà l'ultima configurazione salvata. Tutti i passaggi devono essere completati; in caso contrario, lo schermo continuerà con la configurazione precedente. Procedere con la calibrazione del peso dopo LF2. Premere il tasto per iniziare e lo schermo visualizzerà il VALORE INTERNO. Premere per uscire dal menu e la bascula si riavvierà automaticamente. 																														
262 144	<ul style="list-style-type: none"> Premere il tasto per continuare con la configurazione. (premere per uscire dalla configurazione e tornare al menu LF2). 																														
10000 1	<ul style="list-style-type: none"> Utilizzare , , e quindi per selezionare le UNITÀ e la MODALITÀ DI PESATURA secondo la tabella precedente. (premere per uscire dalla calibrazione e tornare al menu LF2). 																														
000000kg	<ul style="list-style-type: none"> Utilizzare , , e quindi per selezionare la CAPACITÀ MASSIMA, tenendo in considerazione il numero di decimali che si selezionerà nel passaggio seguente. (premere per uscire dalla calibrazione e tornare al menu LF2). 																														
d 0.0kg	<ul style="list-style-type: none"> Utilizzare , e quindi per spostare il punto decimale. (premere per uscire dalla configurazione e tornare al menu LF2). 																														
d.v 0 1	<ul style="list-style-type: none"> Utilizzare e quindi per cambiare il gradino (premere per uscire dalla configurazione e tornare al menu LF2). 																														
LF2	<ul style="list-style-type: none"> Utilizzare , e per continuare con altre configurazioni o premere per uscire dal menu e la bascula si riavvierà automaticamente. 																														

VELOCITÀ DEL CONVERTITORE AD LF4









SPEED 1 velocità standard 15Hz.

SPEED 2 alta velocità 30Hz.



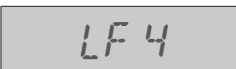





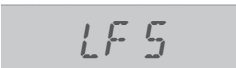

SPEED 3 bassa velocità 7.5Hz

*Questa funzione rimane bloccata quando UF-5 è in modalità HOLD 1.

*Il valore di fabbrica 1

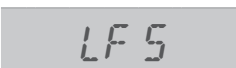
DISPLAY	DESCRIZIONE E SEQUENZA D'USO
	• Premere  per iniziare o  per uscire dal menu e la bascula si riavvierà automaticamente.
	• Premere  e quindi  per selezionare la velocità del convertitore AD (premere  per uscire dalla configurazione e tornare al menu LF4).
	• Premere  ,  e quindi  per continuare con altre regolazioni o premere  per uscire dal menu e la bascula si riavvierà automaticamente.

CIECA LF5

DISPLAY	DESCRIZIONE E SEQUENZA D'USO
	<p>ZP 0 OFF</p> <p>ZP 1 Una suddivisione non verrà mostrata quando è a zero</p> <p>ZP 2 Due suddivisioni non verranno mostrate quando è a zero</p> <p>ZP 3 Tre suddivisioni non verranno mostrate quando è a zero</p> <p>ZP 4 Quattro suddivisioni non verranno mostrate quando è a zero</p> <p>ZP 5 Cinque suddivisioni non verranno mostrate quando è a zero</p> <p>*Questa funzione rimane bloccata quando UF-5 è in modalità HOLD 1</p> <p>*Il valore di fabbrica è ZP 0</p>
	• Premere  per iniziare o  per uscire dal menu e la bascula si riavvierà automaticamente.
	• Utilizzare  e quindi  per selezionare le suddivisioni che non verranno mostrate a zero. (premere ESC per uscire dalla configurazione e tornare al menu LF4)
	• Utilizzare  ,  e quindi  per continuare con altre regolazioni o premere  per uscire dal menu e la bascula si riavvierà automaticamente.

CONFORMITÀ DI APPROVAZIONE *LF 6*

DISPLAY

LF 6



DESCRIZIONE E SEQUENZA D'USO

nonE Versione non verificata **OIML** versione verificata
NON MODIFICARE PER NESSUN MOTIVO QUESTO PARAMETRO.

La modifica di questo parametro implica il blocco di alcune funzionalità.

GRAVITÀ *LF 7*

*Prima di effettuare la prima calibrazione, inserire la gravità della propria zona.

*Dopo aver effettuato la calibrazione, inserire la gravità di destinazione.

*Il valore della gravità sarà rifiutato se è maggiore di 9.83217 (gravità del polo) o minore di 9.78031 (gravità dell'equatore). Valore di fabbrica: 9.801

DISPLAY

LF 7



-00-



9.8035



9.8035







DESCRIPCIÓN Y SECUENCIA DE USO

• Premere  per continuare o  per uscire dal menu e la bilancia si riavvierà automaticamente.

• Lo schermo mostrerà il numero di precalibrazione per un secondo.

• Premere  per continuare.

• Utilizzare ,  e , **0 ~ 9** e quindi  per inserire il valore della gravità (premere ESC per uscire dalla configurazione e tornare al menu LF 7).

ZERO INIZIALE *LF 8*

SEIZ Y resetta il punto dello zero ogni volta che si riavvia la bilancia

SEIZ n reset del punto zero OFF

DISPLAY

LF 8







Seiz Y







LF 8

DESCRIZIONE E SEQUENZA D'USO

• Premere  per iniziare o  per uscire dal menu e la bilancia si riavvierà automaticamente.

• Utilizzare  e  quindi  per selezionare la modalità dello zero iniziale (premere  per uscire dalla configurazione e tornare al menu LF8)

• Utilizzare ,  e quindi  per continuare con altre regolazioni o premere  per uscire dal menu e la bilancia si riavvierà automaticamente.

11. GARANZIA

Questo indicatore è protetto da una garanzia contro qualsiasi difetto di fabbricazione e di materiali della durata di un anno a partire dalla data di consegna. Durante questo periodo, GIROPÈS SL si farà carico della riparazione della stesso.

Questa garanzia non include i danni causati da uso improprio o sovraccarichi.

La garanzia non copre le spese di spedizione (trasporto) necessarie alla riparazione dell'indicatore.

1. SPECIFICATIONS

BR16

Precision	Clase III
Load Cell Sensitivity Range	1.5 ~ 3.0mV/V
Nonlinearity	≤0.01%F.S
Voltage cell	DC 5V
Step	1/2/5 (selectable)
Frequency of sampling	20 times per second (outside meteorology)
Internal resolution	300.000~600.000

2. EXCITATION

BR16

Input	230~240V
Output	10V 600mA
Rechargeable Battery	6V/4Ah

3. BEFORE ITS USE

1. Use an independent electric source to prevent electronic disturbances.
2. Don't place any object on the platform when switching on the indicator.
3. Please, warm-up the scale during 2-3 minutes before using it.
4. Avoid sudden changes in temperature and draughts.
5. Don't overload the scale; do not exceed its maximum capacity.

4. CONSUMPTION

- Normal consumption at rest: approx. 12mA - 333h
- Consumption with backlight: aprox. 36mA - 111,11h
- Consumption with backlight and output RS-232: aprox. 48mA-83h
- Battery duration: without backlight, aprox. 320 h

5. LOAD CELL CONNECTION TO THE INDICATOR

- 1) The connector of the load cell is 7 pins.
- 2) When the indicator is working, do not remove the connector from the load cell, this act could damage the equipment.

7 PIN CELL SCHEME

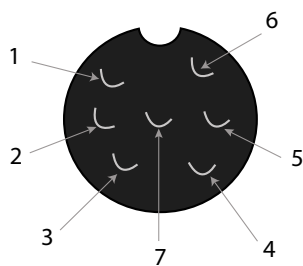
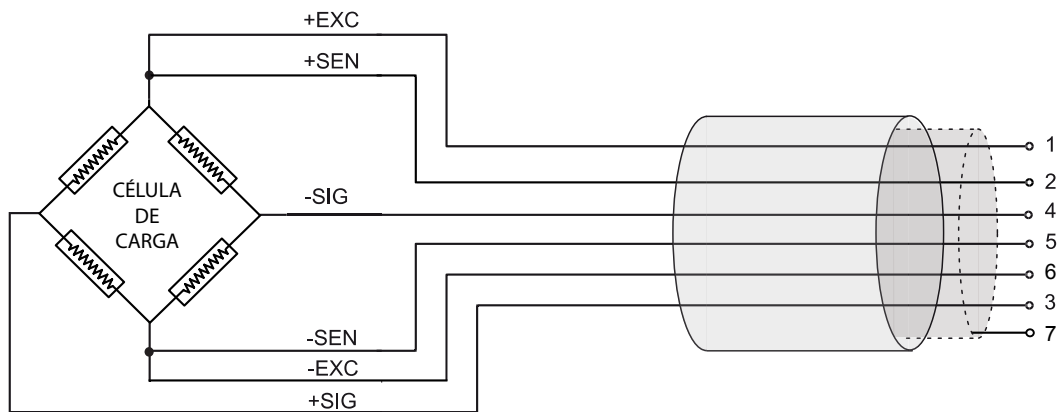

PIN 1	EXC +
PIN 2	SEN +
PIN 3	SIG +
PIN 4	SIG -
PIN 5	SEN -
PIN 6	EXC -
PIN 7	GND

CONNECTION RS232

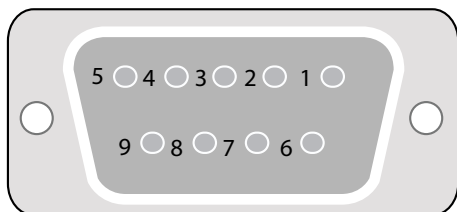

2	Tx
3	Rx
5	GND

PROTOCOL

UART signal of EIA-RS232 C

SIGNAL UART EIA-RS232 C	
Serial output	1200 / 2400 / 4800 / 9600 / 19200 / 34800 bps
Data Bits	8 bits
Parity bits	No
STOP BITS	1 bit

HEAD INFORMATION

HEAD 1 (2 BYTES)	HEAD 2 (2 BYTES)
OL – Extracharge	
ST – Stable	NT – Net weight
US – Unstable	GS – Net weight

6. KEYBOARD DESCRIPTION

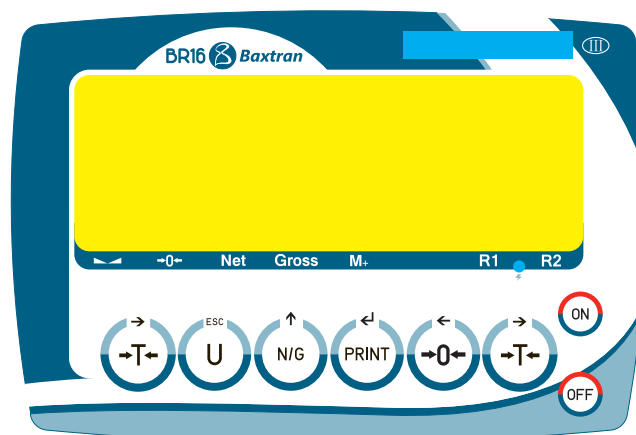

Press this key to turn on the balance.



Press and hold this key for 2 seconds to turn off the indicator.



1^o function To change the weighing unit.

2^o function To exit a menu.



1^o function To set the display reading to zero "0", the display value must be less than $\pm 2\%$ of the maximum capacity.

2^o function To move a space to the left or down into the programming mode.



1^o function To subtract the weight of a container.

2^o function To move a space to the right or up in the programming mode.



1^o function To display the net or gross weight of a product when a tare has been made. When the gross weight of the product is displayed the other keys are disabled.



2^o function To increase the values within the programming mode.





1^o function Manual transmission of data through the RS-232 port to a PC or printer and according to chosen mode.

2^o function Confirmation key in programming mode.

7. PIECE COUNTING MODE





1. Press the key  until the symbol **PCS** appears on the screen
2. Press the key  successively to choose the quantity of pieces of the sample. On the screen will appear, successively, C10/C20/C50/C100/C200.
3. Place the sample on the platform, and wait until the sign of stability and press the key .
4. Place the product on the platform and the screen will show the number of pieces.

The accumulation and the sending of data will depend on the mode chosen in the section [UF-6](#).

- To turn to the normal weighing mode, press the key .
- If the user wants to go back to the piece counting mode, using the same sample of reference, press the key  again.
- If the user want to change the sample of reference, the user must repeat the steps described above.





8. PARAMETERS CONFIGURATION

8.1	INTERNAL COUNTING (A/D)	UF-1
8.2	CONFIGURATION OF THE WEIGHT LIMITS (SUPERIOR AND INFERIOR)	UF-2
8.3	AUTO SWITCH OFF	UF-3
8.4	CONFIGURATION OF THE ILLUMINATION OF THE DISPLAY	UF-4
8.5	HOLD FUNCTION	UF-5
8.6	RS-232 DATA EXIT	UF-6
8.7	CONFIGURATION OF THE SPEED OF THE AD CONVERTER	UF-7
8.8	BLIND	UF-8
8.9	CONFIGURATION OF THE GRAVITY	UF-9





To access the configuration of parameters when the screen is in zero, the user must press at the same time the keys  and . Press the key  or  to choose the desired character (UF-1 ~ UF-11).

To go back to the previous mode press the key .

8.1 INTERNAL COUNTING (A/D) | UF-1

1. Press the key  to view the internal sums of the scale.
2. To go to the next parameter, press the key  the screen will show the value of the voltage of the battery.
3. To exit this mode and go back to the normal weighing, the user must press the key  or .

8.2 CONFIGURATION OF THE LIMITS OF WEIGHT (SUPERIOR AND INGERIOR) | UF-2

1. Press the key  to access the parameter.
2. The display will show the message "000.00L" (inferior limit)
3. Use the keys  and  to move the cursor and the key  to choose the desired number..
4. Press the key  to confirm.

5. The display will show the message "000.00h" (Superior limit=**Hi**)

6. Use the keys  and  to move the cursor and the key  to choose the desired number.

Note: If you need to change or modify the last digit you can place the cursor on it to do it.

7. Press the key  to confirm.

8. The display will show the value.

A B C
0 0 0
(configuration of the alarm)

DISPLAY	VALUE	ESTABILITY
A	0	There is no need to stabilize the alarm to make it ring
	1	The alarm must be stabilized to ring
B	0	Always 0
	1	Alarm switched off
C	0	The alarm ring if it is place on the band OK (between the limits Lo and Hi)
	2	The alarm rings if it is situated below the inferior limit Lo or above the superior limit Hi



9. Press the keys  and  to move the cursor and the key  to choose the desired number..

10. Press the key  to confirm.

The indications on screen **Lo**, **Ok**, **Hi** will appear on screen depending on the weight.

8.3 AUTO SWITCH OFF | UF-3

MODES:

- **AoFF 00** – Auto switch off deactivated
- **AoFF 01** – Auto switch off activated in a minute. The scale is going to switch off automatically after 1 minute of not being used.
- You can configure the value wished from 1 to 99 minutes.

1. Press the key  to have an access to the parameter.

2. Press the keys  and  to move the cursor and the key  to choose the desired number.

3. Press the key  to confirm.

8.4 DISPLAY BACKLIGHTING | UF-4

MODES:

- **A**: Automatic.
- **ON**: Illumination Activated.
- **OFF**: Illumination Deactivated.

1. Press the key  to have an access to the parameter.

2. Press the key  to select the desired mode.

3. Press the key  to confirm.

8.5 HOLD FUNCTION | UF-5









(Once the object is retired from the plate, the display maintains the weight fixed during some seconds. This function is very useful for the weighing of animals)

1. Press the key  to access to the parameter.
2. Press the key  to choose the desired mode.
3. Press the key  to confirm.



MODES:

- **HOLD 0** : Deactivated.
- **HOLD 1** : Animal in movement
- **HOLD 2** : Value of peak
- **HOLD 3** : Hold steady
- **HOLD 4** : Hold steady with self cancelling at zero.



HOLD 1.

- When the user can access this parameter, the screen shows the message **Pct**,
- Use the keys  and  to move the cursor and the key  to choose the desired value of the range of HOLD, you can choose a number from 001 to 100.
- Press the key  to confirm.
- It will appear on the screen the message **time 8**, use the keys  and  to move the cursor and the key  to choose the number of times you want to repeat during the range of hold.
- Press the key  to confirm. *Example: Pct small and big time means more accuracy and longer stabilization.*

8.6 RS-232 DATA EXIT | UF--6

1. Press the key  to access to the parameter.
2. Press the key  to select the transmission speed desired.
3. Press the key  to confirm.

232 0 EXIT RS-232 DEACTIVATED

FORMAT OF THE DATA	
Format 1 PC	
VARIOUS FORMATS AVAILABLE	ST,GS,+0003. 58 kg <CR><LF>
	ST,GS,+0000250pcs <CR><LF>
CONNECTION SENDING	232 1 Connection sending, without accumulation, when it achieves an estability with format 1
	232 2 Continuous connection sending with format 1
	232 3 Connection sending, without accumulation, manual by pressing the key  with format 1
Formato 2 PC	
VARIOUS FORMATS AVAILABLE	+0000.64kg<CR><LF>
	+0000100pcs<CR><LF>
CONNECTION SENDING	232 4 Connection sending, without accumulation, when it achieves the stability with formato 2
	232 5 Continuous connection sending with formato 2
	232 6 Connection sending, without accumulation, manual by pressing the key  with format 2

Format 3 printer

DIFFERENT POSSIBLE FORMATS

S/N	WT/kg	S/N	WT/pcs
0001	0.64	0001	20
0002	0.70	0002	21
0003	0.64	0003	45
0003	1.98	0003	86

232 7

Connection sending and manual accumulation, passing by zero and pressing the key  with **format 3**.

0002	0.70
------	------

If the user presses the key  twice one after the other when the screen is in 0, the total line is printed

0003	1.98

And the memory of the weights is removed

232 8

Connection sending and automatic accumulation to stability, passing 0 with **format 3**.

If the user presses the key  twice one after the other when the screen is in 0, the total line is printed.

0003	1.98

And the memory of the weights is removed

Format 4 printer

DIFFERENT POSSIBLE FORMATS

TICKET NO.0003	TICKET NO.0002
G 0.64kg	G 20pcs
T 0.00kg	T 0pcs
N 0.64kg	N 20pcs
TOTAL NUMBER OF TICKETS 0003	TOTAL NUMBER OF TICKETS 0002
TOTAL	TOTAL
NET 1.92	NET 40

232 9

Connection sending and manual accumulation, passing 0 and pressing the key  with **format 4**.

TICKET N	O.0003
G	0.64kg
T	0.00kg
N	0.64kg

If the user presses the key  twice one after the other when the screen is in 0, the summarizing of the tickets is printed

TOTAL NUMBER OF TICKETS 0003	
TOTAL	
NET	1.92

And the memory of weights is removed

NOTE: Totalization not available in legal metrology.

232 10

Connection sending and automatic accumulation to stability, passing 0 and pressing the key  with **format 4**.

TICKET NO.0003	
G	0.64kg
T	0.00kg
N	0.64kg

If the user presses the key  twice one after the other when the screen is in 0, the summarizing of the tickets is printed. And the memory of weights is removed

TOTAL NUMBER OF TICKETS 0003	
TOTAL	
NET	1.92

And the memory of weights is removed

NOTE: Totalization not available in legal metrology.

FORMAT 1 (232 1 ~ 3):

18 BYTES ASCII FOR THE UNITIES kg, g, t, lb

1	2	,	1	2	,	1	2	3	4	5	6	7	8	1	2	CR	LF
Headboard 1			Headboard 2			data								Unit			

21 BYTES ASCII FOR THE UNITIES tl, T, lboz

1	2	,	1	2	,	1	2	3	4	5	6	7	8	9	1	2	3	4	CR	LF
Headboard 1			Headboard 2			data									Unit					

19 BYTES ASCII FOR THE UNIT pcs

1	2	,	1	2	,	1	2	3	4	5	6	7	8	1	2	3	CR	LF
Headboard 1			Headboard 2			data								Unit				

FORMAT 2 (232 4 ~ 6):

12 BYTES ASCII FOR THE UNITIES kg, g, t, lb

1	2	3	4	5	6	7	8	1	2	CR	LF
data								Unit			



15 BYTES ASCII FOR THE UNITIES tl, T, lboz

1	2	3	4	5	6	7	8	9	1	2	3	4	CR	LF
data									Unit					

13 BYTES ASCII FOR THE UNIT pcs

1	2	3	4	5	6	7	8	1	2	3	CR	LF
data								Unit				

8.7 CONFIGURATION OF THE SPEED OF THE CONVERTER | UF--7

1. Press the key  to access the parameter.
2. Press the key  to choose the desired mode:
 - Mode 1 : Normal
 - Mode 2: Fast
 - Mode 3: Slow
3. Press the key  to confirm.

8.8 BLIND | UF--8



It appears 0 on screen until the next division is selected. It starts to show values from that division.

Example:

Scale with $e = 2g$

Blind in 5 divisions

It will show 0 until it reaches $25 = 10g$, the first value it will show will be 12g.

1. Press the key  to access the parameter.
2. Press the key  to select.
3. Press the key  to confirm..







8.9 CONFIGURATION OF GRAVITY | UF--9

1. Press the key  to view the value of the actual gravity.
2. To change the value, press the key , next you must use the key  and  to move the cursor and the key  to select the desired number.
3. Press the key  to confirm.



9. CONFIGURATION OF THE READJUSTMENTS IN CALIBRATION

1. When the user is in the normal mode of weighing, he must press the keys  and , the message **ECF-1** is going to appear on the display.
2. Press the keys  or  to select the desired function: **ECF-1**, **ECF-2** or **ECF-3**







* ECF-1 CALIBRATION OF ZERO + WEIGHT

- Press the key , the display will show CALZ.
- Press the key , to put the reading of the display to zero.
- Press the keys  and  to move the cursor.
- Press the key , to introduce the value of the weight of calibration.
- Place the weight of calibration on the platform and press the key , to do the calibration once the reading is steady.

* ECF-2 CALIBRATION OF ZERO

- Press the key , the display will show CALZ.
- Press the key , to put the reading of the display to zero.
- Press the key , to calibration.









* CALIBRATION OF WEIGHT (SPAN)

- Press the key , the display will show the value of the weight of calibration.
- Press the keys  and  to move the cursor.
- Pulsar la tecla , to modify the value of the weight of calibration.
- Pulsar la tecla , to confirm.
- Place the weight of calibration on the platform and press the key , to do the calibration once the reading is stable.

10. TECHNICAL PARAMETERS

DO NOT MODIFY THE TECHNICAL PARAMETERS IF IT IS NOT STRICTLY NEEDED. A BAD CONFIGURATION OF THIS SECTION CAN CAUSE A WRONG FUNCTIONING OF THE SCALE.

ENTRANCE AND EXIT OF THE CALIBRATION

DISPLAY	DESCRIPTION AND SEQUENCE OF USE
	<ul style="list-style-type: none"> • With the visor switched off, press and hold the key  until the message <i>P000</i>, appears on the screen, then you can release the key . • With the keys ,  and  introduce the code <i>0020</i>. • Press the key  to start or the key  to exit the menu and the indicator will begin again automatically.

CALIBRATION OF THE WEIGHT LF 1

DISPLAY	DESCRIPTION AND SEQUENCE OF USE
LF 1	✘ The calibration can be done with any weight, but the weight ca not be inferior to 1/100 of the maximum capacity and it must also never be exceeded.
CAL 2	• Press the key to start the calibration of zero (press To exit the calibration and go back to the menu LF1)
150.00 kg	• Use , and , 0 ~ 9 and then press to introduce the weight with which the calibration will be done. (press the key to exit the calibration and go back to the menu LF1)
150.00 kg	• Place the required weight on the scale as it is indicated in the display.
150.00 kg	• Once everything is steady, press the key to calibrate it (press the key ESC to exit the calibration and go back to the menu LF1).
	THE CALIBRATION IS GOING TO FINISH AND THE SCALE WILL GO VACK TO THE WEIGHING MODE AUTOMATICALLY.

CONFIGURATION LF 2

DISPLAY	DESCRIPTION AND SEQUENCE OF USE																														
FIRST STEP	• DISPLAY OF THE INTERNAL COUNTING																														
262 144	• POSSIBLE VALUES OF THE PARAMETERS																														
SECOND STEP	<table border="1"> <tr> <td>A: Metric system</td> <td>0:NO</td> <td>1: kg</td> <td>2:T</td> <td>3:g</td> </tr> <tr> <td>B: American system</td> <td>0:NO</td> <td>1: lb</td> <td>2:lb oz</td> <td></td> </tr> <tr> <td>C: other unities</td> <td>0:NO</td> <td>1: TW kg</td> <td>2:HK kg</td> <td>3:VISS</td> </tr> <tr> <td>D: PCS</td> <td>0:OFF</td> <td>1: ON</td> <td></td> <td></td> </tr> <tr> <td>E: double range</td> <td>0:OFF</td> <td>1: multi interval</td> <td>2:multi range</td> <td></td> </tr> <tr> <td>F: units of calibration</td> <td></td> <td>1:use metric unities</td> <td>2:use american unities</td> <td></td> </tr> </table>	A: Metric system	0:NO	1: kg	2:T	3:g	B: American system	0:NO	1: lb	2:lb oz		C: other unities	0:NO	1: TW kg	2:HK kg	3:VISS	D: PCS	0:OFF	1: ON			E: double range	0:OFF	1: multi interval	2:multi range		F: units of calibration		1:use metric unities	2:use american unities	
A: Metric system	0:NO	1: kg	2:T	3:g																											
B: American system	0:NO	1: lb	2:lb oz																												
C: other unities	0:NO	1: TW kg	2:HK kg	3:VISS																											
D: PCS	0:OFF	1: ON																													
E: double range	0:OFF	1: multi interval	2:multi range																												
F: units of calibration		1:use metric unities	2:use american unities																												
A B C D E F	✘ lb oz cannot be selected as unities of calibration.																														
	✘ The scale won't let us continue up to the next step if there is a mistake during the programming.																														
THIRD STEP	• Use , and , 0 ~ 9 and then press to introduce THE MAXIMUM CAPACITY, considering the number of decimal zeros to be used. Ex. 150.00kg = introduce 15000 if then selected as decimal d0.00																														
000000kg																															
FOURTH STEP	• Use the Keys , to change the position of the DECIMAL POINT.																														
dP 0.0	<table border="1"> <tr> <td>d 0.00</td> <td>d 0.000</td> <td>d 0.0000</td> <td>0.00000</td> </tr> </table>	d 0.00	d 0.000	d 0.0000	0.00000																										
d 0.00	d 0.000	d 0.0000	0.00000																												
FIFTH STEP	• Use to select the DIVISION:																														
d.V 0 1	d.V 0 1, d.V 02, d.V 05, d.V 10, d.V 20, d.V 50																														

✘ After introducing the parameters LF2, the indicator will show the last configuration saved. All the steps to follow must be completed, if they are not done the indicator will continue with the previous configuration.

✘ Proceed with the calibration of weight after LF2.

LF 2



• Press the key to start and display the internal value. Press to exit the menu and the scale will automatically restart.

262 144



• Press the key To continue with the configuration. (press the key to exit from the configuration and go back to the menu LF2).

10000 1



• Use the keys , and , 0 ~ 9 and then press the key to choose the UNITS OF WEIGHT . (press the key to exit from the configuration and go back to the menu LF2).

000000kg



• Use the keys , and , 0 ~ 9 and then press the key to choose the MAXIMUM WEIGHT. press the key to exit from the configuration and go back to the menu LF2).

d 0.0kg



• Use the keys , and Then To move the decimal point (press the key To exit from the configuration and go back to the menu LF2).

d 0.0 1



• Use and then to change the step. (Press the key To exit from the configuration and go back to the menu LF2).

LF2



• Use , and then To continue with the other configuration or press the key to exit from the menu and the scale will begin again automatically).



SPEED OF THE AD CONVERTER LF 4

SPEED 1 standard speed 15Hz.

SPEED 2 high speed 30Hz.

SPEED 3 low speed 7.5Hz

*This function stays blocked when UF-5 is in mode HOLD 1.

*The value of factory is 1

DISPLAY

DESCRIPTION AND SEQUENCE OF USE

LF4



• Press the key to start or the key to exit from the menu and the scale is going to begin again automatically.

SPEED 1



LF 4

• Use the key and then the key to select the speed of the AD converter (press the key U) to exit from the configuration and go back to the menu LF4)

• Use the keys , and then To continue with the other adjustment and press the key U) to exit from the menu and the scale will start again automatically.

BLINF LF 5

DISPLAY

DESCRIPTION AND SEQUENCE OF USE

LF 5

ZP 0 OFF

ZP 1 One division will not show being at zero

ZP 2 Two division will not show being at zero

ZP 3 Three divisions will not show being at zero

ZP 4 Four divisions will not show being at zero

ZP 5 Five divisions will not show being at zero

*This function is going to be blocked when UF-5 is in mode HOLD 1

*The value of factory is ZP 0

DISPLAY

DESCRIPTION AND SEQUENCE OF USE

LF 5



• Press the key to start or the key U) to exit from the menu and the scale will start again automatically.

ZP 0



• Use the key and the key to select how many divisions will show when in zero (press **ESC** to exit from the configuration and go back to the menu LF4)

LF 5

• Use the keys , and then the key to continue with other adjustment or press the key U) to exit from the menu and the scale is going to start automatically.

APPROVAL CONFIRMITY LF 6

DISPLAY

DESCRIPTION AND SEQUENCE OF USE

LF 6



nonE Version not approved

DON'T MODIFY, IN NO WAY, THIS PARAMETER. IT MUST ALWAYS BE CONFIGURED AT nonE.

The change of this parameter implies the blocking of some functionalities.

GRAVITY LF 7

*Introduce the gravity of your zone before doing the first calibration.

*Introduce the gravity of destination after doing the calibration.

*The value of the gravity will be denied if it is bigger than 9.83217 (gravity of the pole) or inferior to 9.78031 (gravity of the equator).

Value of factory: 9.8035

DISPLAY

DESCRIPTION AND SEQUENCE OF USE



- Press the key to continue or the key to exit from the menu and the scale will start again automatically.



- The screen is going to show the number of pre-calibration during one second.



- Press the key to continue.

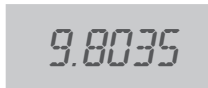

- Use the keys and , 0 ~ 9 and then the key to introduce the value of gravity (press ESC to exit from the configuration and go back to the menu LF7)

INITIAL ZERO LF 8

SEIZ Y resets of the point of zero every time that the scale is begun again.

SEIZ n resets of the point zero OFF

DISPLAY

DESCRIPTION AND SEQUENCE OF USE



- Press the key to start or the key to exit from the menu and the scale will start again automatically.

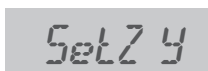

- Use the key and then the key to choose the mode of zero initial (press the key ... to exit from the configuration and go back to the menu LF8)



- Use the keys , and then the key to continue with other adjustments o press the key to exit from the menu and the scale will start again automatically.

11. GUARANTEE

This scale has a warranty against all manufacture and material defects, for a period of a year starting with the delivery date.

During this period, GIROPES, will be in charge of the repairing of the scale.

This warranty does not include the damages done by overload or wrong use.

The warranty does not cover the delivery expenses necessary for the repair of the scale.



marca propiedad de | est une marque de | trade mark propriety of:

GIROPES

Pol. Empordà Internacional Calle F. Parcela 15-16
17469 VILAMALLA - (Girona) SPAIN
T. (34) 972 527 212 - F. (34) 972 527 211